

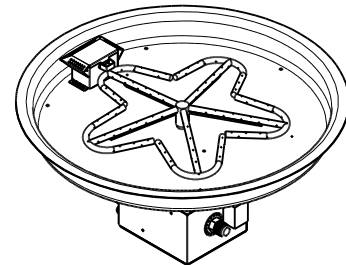

**Hearth Products Controls Co**  
**CSA CERTIFIED-OUTDOOR USE ONLY**  
**FOR COMMERCIAL AND RESIDENTIAL USE**

HEARTH PRODUCTS CONTROLS  
 3050 PLAINFIELD RD.  
 KETTERING, OH 45432  
 TOLL FREE: 1-877-433-7001  
 PHONE: (937) 433-7000  
 FAX: (937) 433-0704  
 www.hpcfire.com

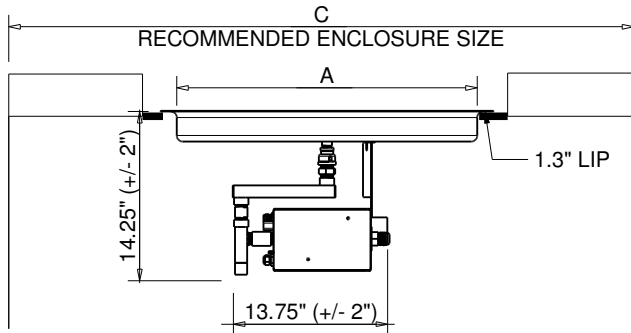

ISOMETRIC VIEW

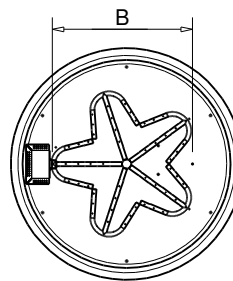

PLAN VIEW

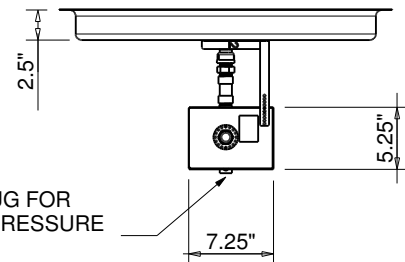

SIDE ELEVATION

AVAILABLE IN:

- 120VAC OR 24VAC
- On/Off OR Hi/Low

MATERIAL: 304 STAINLESS STEEL

Hi/Lo MODELS HAVE A 40% REDUCTION IN BTU ON LOW SETTING

PART NUMBERS	STND BTU	DIMENSION CHART		
PENTA BURNER		A"	B"	C"
PENTA19EI	65K	19	12	54
PENTA25EI	125K	25	18	72
PENTA31EI	200K	31	24	72
PENTA37EI	250K	37	30	80
PENTA43EI	400K	43	36	90

PART NUMBERS	STND BTU	DIMENSION CHART		
ROUND BURNER		A"	B"	C"
13SSEI	90K	13	12	54

Notes:

- PROPER VENTING
  - ENCLOSURES: Recommend 4 each 18 sq.in. vents on opposing sides (Minimum 2 each 18 sq.in. vents).
  - BOWLS (Copper, concrete or metal) - Bowl to be raised above mounting surface minimum of 3/4" gap; Bowl to have a minimum of 6" diameter hole in bottom
- GAS SUPPLY - FOR USE WITH FIXED PIPING SYSTEMS ONLY - NOT FOR USE WITH SMALL TANKS.
  - Natural Gas: Operating Supply Pressure: Minimum: 6.0" W.C.; Maximum: 7.0" W.C.
  - LP Gas: Operating Supply Pressure: Minimum: 10.0" W.C.; Maximum: 11.0" W.C.

IMPORTANT: Ensure any flex line that may be used from the permanent main fuel supply to the product is rated to the stated max btu of the product and certified to ANSI Z21.75\*CSA 6.27.

- MODIFICATION OF PRODUCT WILL VOID ANY CERTIFICATION AND WARRANTY.
- FOLLOW ALL MANUFACTURER INSTALLATION INSTRUCTIONS AND LOCAL CODES.
- ALL DIMENSIONS ARE CONSIDERED TRUE AND REFLECT MANUFACTURER'S SPECIFICATIONS AS OF THE REVISION DATE.
- DO NOT SCALE DRAWING.
- THESE DRAWINGS ARE FOR SIZING AND PLANNING PURPOSES. ALL INFORMATION CONTAINED HEREIN WAS CURRENT AT THE TIME OF DEVELOPMENT. THE MANUFACTURER'S RESPONSIBLE FOR THE ACCURACY OF THE DRAWING.
- CONTRACTOR'S NOTE: FOR PRODUCT AND COMPANY INFORMATION VISIT [www.CADdetails.com/info](http://www.CADdetails.com/info) REFERENCE NUMBER 771-043.

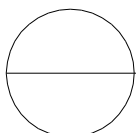

ELECTRONIC IGNITION

EI BOWL ROUND PAN - FLAME SENSING WITH ELECTRONIC HOT SURFACE IGNITION