

CDA2431 INSTALL GUIDE

DIMENSIONAL RENDERINGS

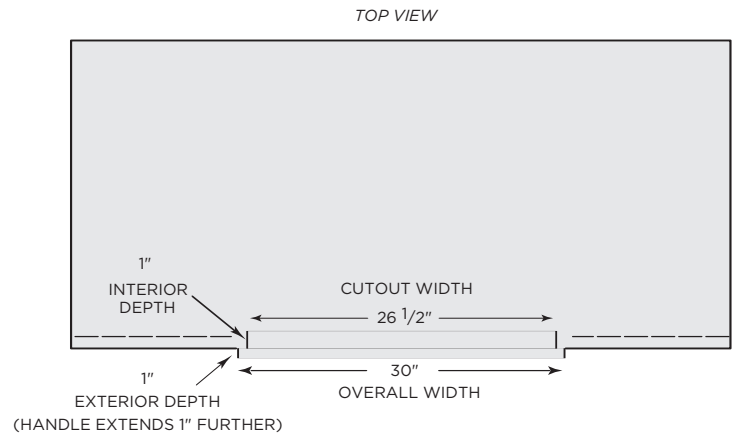
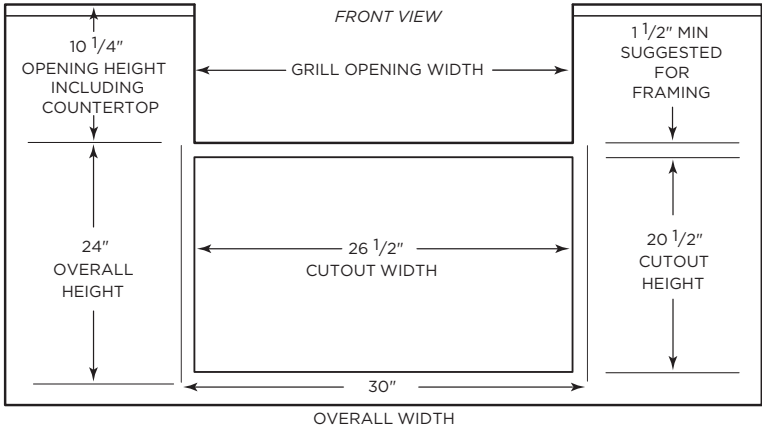
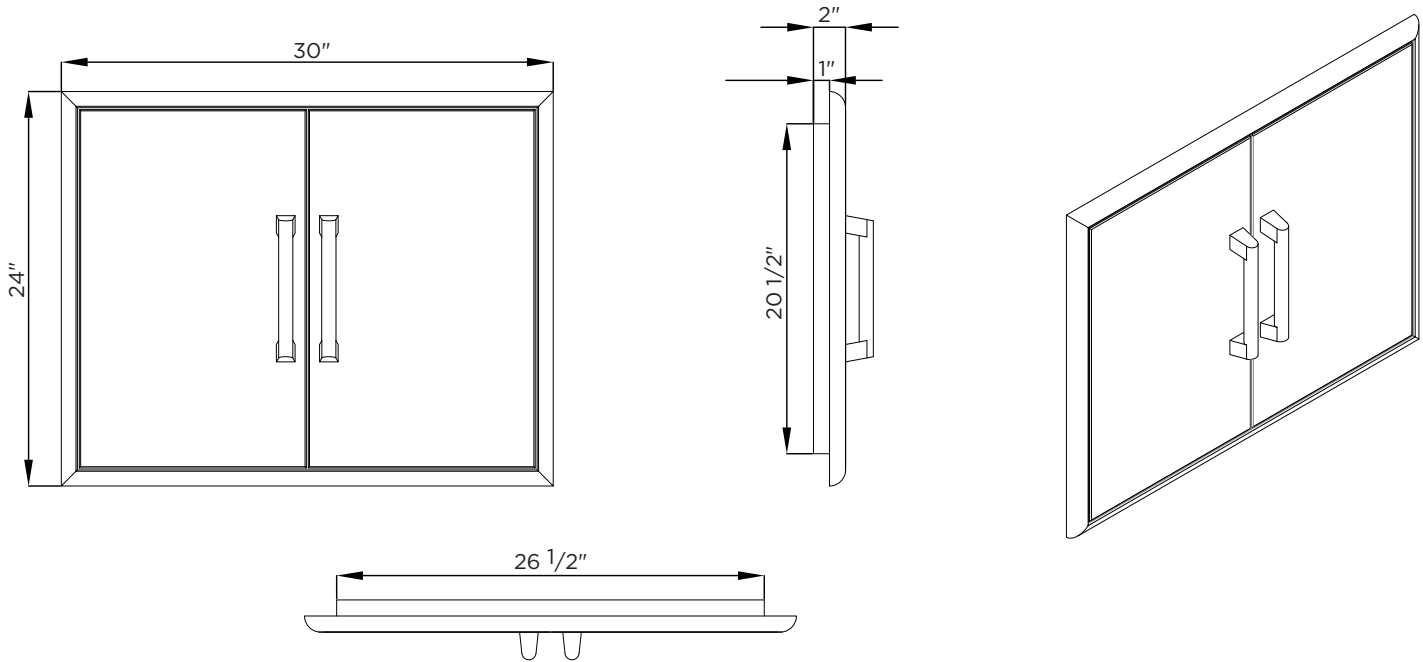

Overall Product Dimensions			
Model No.	Height	Width	Depth
CDA2431	24"	30"	3"

Cutout Dimensions for Island			
Model No.	Height	Width	Depth
CDA2431	20 1/2"	26 1/2"	1"

Install Notes:

- ✓ 2 anchor points are located on each side of the doors interior frame (top, bottom, left and right)
- ✓ Due to wide variance of possible building materials, anchors are not included
- ✓ When inserting your anchors be sure to use a framing square to ensure the door is not pulled out of square
- ✓ These specs are accurate but we always suggest having the product physically on site to ensure full understanding of how this product will coordinate with your build