

# FIREMAGIC®

## AURORA

SINGLE SIDEBURNER AND  
DOUBLE SIDEBURNER  
3279(P)L-1, 3281(P)L Series

### INSTALLATION AND OWNER'S MANUAL

**INSTALLER:** Leave these instructions with consumer.

**CONSUMER:** Retain for future reference.



**Important:** READ THESE INSTRUCTIONS CAREFULLY BEFORE STARTING INSTALLATION

### WARNINGS AND SAFETY CODES

#### ⚠ DANGER:

##### IF YOU SMELL GAS:

1. Shut off the gas to the appliance.
2. Extinguish any open flame.
3. Open lid.
4. If odor continues, keep away from the appliance and **immediately** call your gas supplier or the fire department.

**CODE AND SUPPLY REQUIREMENTS:** This appliance must be installed in accordance with local codes and ordinances, or, in the absence of local codes, with the latest *National Fuel Gas Code (ANSI Z223.1/NFPA 54)*, or *Natural Gas and Propane Storage and Handling Installation Code (CSA-B149.1)*.

This appliance and its dedicated manual shutoff valve must be disconnected from the gas-supply piping system when testing the system at pressures in excess of ½ psig (3.5 kPa).

This appliance must be isolated from the gas-supply piping system by closing its dedicated manual shutoff valve during any pressure testing of the gas-supply system at pressures up to and including ½ psig (3.5 kPa).

**Proper operation of your appliance requires prompt and periodic maintenance. See the SERVICING AND CLEANING section for details.**

#### ⚠ WARNING:

1. Do not store or use gasoline or other flammable vapors and liquids in the vicinity of this or any other appliance.
2. An LP cylinder not connected for use shall not be stored in the vicinity of this or any other appliance.

#### ⚠ WARNING:

Improper installation, adjustment, alteration, service, or maintenance can cause injury or property damage. For proper installation, refer to the installation instructions. For assistance or additional information, consult a qualified professional service technician, service agency, or the gas supplier.

All electrical outlets in the vicinity of the appliance must be properly grounded in accordance with local codes, or, in the absence of local codes, with the *National Electrical Code, ANSI/NFPA 70*, or the *Canadian Electrical Code, CSA C22.1*, whichever is applicable.

Keep all electrical-supply cords and fuel-supply hoses away from any heated surface.



Certified to: ANSI Z21.58  
CSA 1.6

# INSTALLATION INSTRUCTIONS ET MANUEL DU PROPRIÉTAIRE DANS LE CONTRE- SINGLE ET DOUBLE SIDEBURNER

**⚠ DANGER:**

**SI VOUS SENTEZ LE GAZ :**

1. Coupez le gaz à l'appareil.
2. Éteignez-vous n'importe quelle flamme nue.
3. Ouvrez le couvercle si équipé d'un four.
4. Si l'odeur continue, gardez loin de l'appareil et appelez immédiatement votre département de fournisseur ou de feu de gaz.

**⚠ AVERTISSEMENT:**

1. Ne stockez pas ou n'employez pas l'essence ou d'autres vapeurs et liquides inflammables à proximité de ceci ou d'aucun autre appareil.
2. Un cylindre de propane non relié pour l'usage ne sera pas stocké à proximité de ceci ou d'aucun autre appareil.

**CONDITIONS DE CODE ET D'APPROVISIONNEMENT:**

Ce gril doit être installé selon des codes et des ordonnances locaux, ou, en l'absence des codes locaux, avec l'un ou l'autre le plus défunt *Code national de gaz de carburant* (norme ANSI Z223.1/NFPA 54), et *Stockage de gaz naturel et de propane et manipulation du code d'installation* (CSA-B149.1).

Cet appareil et ses différents robinets d'isolement doivent être démontés du gaz-fournissent le système sifflant en examinant le système aux pressions au-dessus du ½ psig (kPa 3.5).

Cet appareil doit être isolé dans gaz-fournissent le système sifflant par fermeture que ses différents robinets d'isolement manuels pendant tous les essais sous pression du gaz-fournissent le système aux pressions jusques et y compris le ½ psig (kPa 3.5).

- Ce gril est pour utilisation à l'extérieur seulement. Si l'appareil est entreposé à l'intérieur, enlever les bouteilles et les laisser à l'extérieur.
- Ne pas ranger le gril immédiatement après l'avoir utilisé. le laisser refroidir avant de le déplacer ou de la ranger. Le non respect de cette mesure de sécurité pourrait entraîner un incendie causant des dommages à la propriété, des blessures ou la mort.
- Ne pas utiliser cet appareil sous une surface combustible.
- Ne pas utiliser cet appareil sous un auvent. Le non respect de cette mesure de sécurité pourrait entraîner un incendie ou des blessures.
- Dégagement minimal entre les parois latérales et l'arrière de l'appareil et la construction combustible (45.7 cm à partir des parois latérales et 45.7cm à partir de l'arrière).
- Le régulateur de pression de gaz prévu avec cet appareil de cuisson à gaz pour l'extérieur doit être utilisé. Ce régulateur est réglé pour une pression de sortie de 5 pouces de colonne de l'eau pour le gaz naturel, et 10 pouces pour le propane.
- LE RÉGULATEUR INCLUS D'APPAREILS EST ÉVALUÉ POUR LE MAXIMUM DE 1/2 (LIVRES PAR POUCE CARRÉ). SI VOTRE OFFRE DE GAZ EST 1/2 PLUS GRAND QUE (LIVRES PAR POUCE CARRÉ), UN RÉGULATEUR ADDITIONNEL DOIT ÊTRE INSTALLÉ AVANT LE GRIL. VOIR LA SECTION DE CONDITIONS

**⚠ AVERTISSEMENT:**

L'installation inexacte, l'ajustement, le changement, le service, ou l'entretien peuvent causer des dommages ou des dégâts matériels. Référez-vous à ce manuel. Pour de l'aide ou des renseignements supplémentaires, consultez un technicien professionnel qualifié de service, une agence de service ou le fournisseur de gaz.

Toutes les sorties électriques à proximité du gril doivent être correctement fondues selon des codes locaux, ou en l'absence de local code, avec le code électrique national, ANSI/NFPA 70, ou le code électrique canadien, CSA C22.1, celui qui est applicable.

Maintenez tout électrique-fournissent des cordes et carburant-fournissent des tuyaux partis de n'importe quelle surface de chauffage.

**D'OFFRE DE GAZ POUR LA PRESSION APPROPRIÉE D'OFFRE DE GAZ.**

- Ne couvrez jamais la surface entière de cuisine ou de gril de gauffreuses ou de casseroles. La surchauffe se produira et les brûleurs ne seront pas très performants quand la chaleur de combustion est emprisonnée au-dessous de la surface à cuire.
- Ne pulvérisez jamais l'eau sur une unité chaude de gaz, comme ceci peut endommager des composants de porcelaine ou de fer de fonte.
- Une fuite de GPL peut causer un incendie ou une explosion si enflammée entraînant des blessures corporelles graves ou la mort.
- Communiquez avec le fournisseur de GPL pour les réparations ou pour disposer de qules bouteille ou du GPL non utilisé.

**Certifié à la norme:   ANSI Z21.58  
  CSA 1.6b**

**INSTALLATEUR : Laissez ces instructions avec le consommateur.  
CONSOMMATEUR : Maintenez pour la future référence.**

# CONTENTS

## GETTING STARTED

INSTALLATION, OPERATION, AND SAFETY INFORMATION.....	4
<i>ELECTRICAL CONNECTIONS</i> .....	4
GAS SAFETY INFORMATION.....	5
<i>WARNING</i> .....	5
<i>WHEN USING PROPANE GAS</i> .....	5
<i>WHEN USING NATURAL GAS</i> .....	5
<i>INSTALLATION SAFETY GUIDELINES</i> .....	5
OPERATING THE UNIT SAFELY AND CORRECTLY.....	5
SAFE USE & MAINTENANCE OF PROPANE GAS CYLINDERS.....	7
ENCLOSURE / VENTILATION REQUIREMENTS.....	8
<i>VENTILATION (ALL ENCLOSURES)</i> .....	8
<i>WHEN A PROPANE (L.P.) CYLINDER IS USED IN THE ENCLOSURE</i> .....	9
INSTALLATION REQUIREMENTS.....	10
<i>OVERHEAD CONSTRUCTION AND EXHAUST HOOD REQUIREMENTS</i> .....	10
<i>SIDE AND REAR WALL CLEARANCES</i> .....	11
<i>BACKSPASH CLEARANCE (if applicable)</i> .....	11
<i>COMBUSTION AIR AND COOLING AIRFLOW</i> .....	12
<i>GAS-SUPPLY PLUMBING REQUIREMENTS</i> .....	12
ELECTRICAL SAFETY.....	13
MODEL SPECIFICATIONS.....	14
<i>COUNTERTOP OVERHANG</i> .....	15
<i>ENCLOSURE VENTILATION</i> .....	15
<i>COMBUSTIBLE ENCLOSURE CUT-OUT</i> .....	16
<i>SUBSTRATE</i> .....	16
<i>WIRING DIAGRAM</i> .....	17
REPLACEMENT PARTS LIST.....	18

## INSTALLATION

INSTALLATION.....	19
<i>COUNTER PREPARATION</i> .....	19
<i>CONNECT THE GAS SUPPLY</i> .....	19
<i>POWER SUPPLY &amp; WIRE HARNESS CONNECTIONS</i> .....	20
<i>SLIDE UNIT INTO ENCLOSURE</i> .....	24
<i>POSITION THE BURNER CAP(S)</i> .....	24
<i>INSTALL THE SIDEBURNER LID</i> .....	24

## USE, CARE, & SERVICE

IDENTIFICATION OF CONTROLS.....	25
USING THE APPLIANCE.....	26
LIGHTING (IGNITION) INSTRUCTIONS.....	27
<i>ELECTRONIC LIGHTING</i> .....	27
<i>MANUAL LIGHTING</i> .....	27
<i>SHUTTING OFF THE UNIT</i> .....	27
SERVICING AND CLEANING.....	29
<i>CLEANING YOUR SIDEBURNER</i> .....	29
<i>CONVERT GAS TYPE / CHECK BURNER ORIFICES</i> .....	31
<i>AIR SHUTTER ADJUSTMENT</i> .....	33
<i>CONTROL PANEL REMOVAL</i> .....	34
<i>BURNER REMOVAL</i> .....	35
<i>SYSTEM RESET</i> .....	35
NOTES PAGE.....	36
TROUBLESHOOTING.....	37
WARRANTY.....	38

## INSTALLATION, OPERATION, AND SAFETY INFORMATION

1. The outdoor appliance and surrounding area **MUST** remain clear of flammable substances such as gasoline, yard debris, wood, etc. Maintain a minimum horizontal clearance of 18" (in all directions) from combustible materials/items.
2. Do not block the 1" front air inlet along the bottom of the control panel. See the COMBUSTION AIR AND COOLING AIRFLOW section under INSTALLATION REQUIREMENTS for details.
3. **This unit must be installed so that the required vent openings and surrounding area of the enclosure remain clear and free at all times. See the ENCLOSURE/VENTILATION REQUIREMENTS section for details.**
4. **When using propane gas: the propane cylinder, regulator, and rubber hose must be in a location not subject to temperatures above 125° F (51° C).**
5. Do not operate the burner with the cover in place.
6. The flames on each burner burn evenly along the entire burner caps with a steady flame (mostly blue). If burner flames are not normal, check and clean the orifice and burner/venturi tubes for insects and insect nests. A clogged tube can lead to a fire beneath the unit. A proper flame pattern will ensure safe operation and optimal performance. Adjust the air shutter as needed (see AIR SHUTTER ADJUSTMENT section).
7. The in-line gas valve or gas cylinder valve must always be shut OFF when the unit is not in use.
8. Whenever reconnecting any wires, apply a small amount of dielectric grease to the male connector, then make the connection. This will ensure conductivity and prevent moisture from affecting the contact.
9. Wear gloves and use extreme caution whenever installing and handling this product and its accessories as certain components have sharp edges that can cause personal injury.

**CAUTION: FOR YOUR SAFETY, you must provide openings in the enclosure for replacement air and ventilation (in case of possible leakage from gas connections or propane cylinders). Failure to do so may result in a fire or explosion causing property damage, bodily injury, or death. See the ENCLOSURE / VENTILATION REQUIREMENTS section for details.**

### **IMPORTANT**

**IN THE EVENT OF A GREASE FIRE, IMMEDIATELY SHUT OFF THE MAIN GAS VALVE TO THE UNIT. ALLOW THE FIRE TO EXTINGUISH ITSELF. KEEP AT A SAFE DISTANCE. A THOROUGH INSPECTION BY A QUALIFIED PROFESSIONAL SERVICE TECHNICIAN SHOULD BE CONDUCTED BEFORE FUTURE USE OF YOUR UNIT. THE SERVICE TECHNICIAN WILL CHECK THE SYSTEM FOR GAS LEAKS AND WILL CHECK ALL ELECTRICAL WIRING FOR DAMAGE. ALL GAS LEAKS AND WIRING MUST BE REPAIRED PRIOR TO FUTURE USE.**

**WARNING: NEVER cover more than 75% of the cooking surface with griddles or pans. Overheating will occur, and burners will not perform properly when combustion heat is trapped below the cooking surface.**

The unit serial identification number and rating label are located on the inside of the control panel.  
The unit must be completely cool before opening.

### **ELECTRICAL CONNECTIONS**

**A 120VAC (15 AMP minimum) GFCI GROUNDED 3-wire receptacle (not included) is required** within the vicinity of the unit to provide power to it. The GFCI receptacle must be a WEATHER-PROOF IN-USE COVERED RECEPTACLE.

- **Observe the National Electric Code and all local codes.**
- **Verify proper polarity of the receptacle.**
- **If an extension cord is used, ensure it is a 3-wire GROUNDED cord that is rated for the power of the equipment, and is approved for outdoor use with a W-A marking. DO NOT use 2-prong adapters.**
- **DO NOT TAMPER WITH THE EXTENSION CORD OR THE UNIT POWER-SUPPLY CORD.**

## GAS SAFETY INFORMATION

**WHEN OPERATING THIS GAS APPLIANCE, ALL INSTRUCTIONS AND WARNINGS MUST BE OBSERVED. FAILURE TO DO SO MAY RESULT IN A FIRE OR EXPLOSION CAUSING PROPERTY DAMAGE, BODILY INJURY, OR DEATH.**

### WARNING

This gas appliance, its enclosure, and the propane cylinder enclosure, if any, **MUST** be plumbed and vented in accordance with local building and safety codes and should be approved by local code enforcement officials. This appliance **MUST** be installed and operated according to the information below.

**FAILURE TO PROPERLY VENT THE ENCLOSURE MAY RESULT IN A FIRE OR EXPLOSION CAUSING PROPERTY DAMAGE, BODILY INJURY, OR DEATH.**

A leaking gas connection or valve unintentionally left open will create a hazard.

### WHEN USING PROPANE GAS

- **Propane gas** (also known as **L.P. gas**) is heavier than air and will accumulate or pool in an inadequately vented enclosure or recessed area.
- If a pool of **propane gas** is ignited, an explosion will occur. Adequate venting at the floor level, or the lowest point where gas could accumulate, will eliminate this danger.  
Refer to the **ENCLOSURE / VENTILATION REQUIREMENTS** section.  
Observe all local codes.
- DO NOT store a spare propane-gas cylinder under or near the enclosure.

### WHEN USING NATURAL GAS

- **Natural gas** is lighter than air and will accumulate at the top of an inadequately vented enclosure.
- If an accumulation of **natural gas** is ignited, an explosion will occur. Adequate venting at the top of the enclosure, or the highest point where gas could accumulate, will eliminate this danger.  
Refer to the **ENCLOSURE / VENTILATION REQUIREMENTS** section.  
Observe all local codes.

### INSTALLATION SAFETY GUIDELINES

**THIS UNIT MUST BE INSTALLED SO THAT THE REQUIRED VENT OPENINGS AND SURROUNDING AREA OF THE ENCLOSURE REMAIN CLEAR AND FREE AT ALL TIMES. See the ENCLOSURE / VENTILATION REQUIREMENTS section for details.**

**CAUTION: FOR YOUR SAFETY, you must provide openings in the enclosure for replacement air and ventilation (in case of possible leakage from gas connections or propane cylinders). Failure to do so may result in a fire or explosion causing property damage, bodily injury, or death. See the ENCLOSURE / VENTILATION REQUIREMENTS section for details.**

The gas cylinder, regulator, and rubber hose must be in a location not subject to temperatures above 125° F (51° C).

IF A PROPANE CYLINDER IS INSTALLED INSIDE OF THE ENCLOSURE, THE GUIDELINES FOUND IN THE **ENCLOSURE / VENTILATION REQUIREMENTS** SECTION MUST BE FOLLOWED.

## OPERATING THE UNIT SAFELY AND CORRECTLY

Every time you use the unit, **make sure that:**

1. The area around the enclosure is clear and free from combustible materials, gasoline and flammable vapors/liquids.
2. There is no blockage of the airflow through the vent openings located on the enclosure.
3. The hose is inspected (if applicable). See SAFE USE & MAINTENANCE OF PROPANE-GAS CYLINDERS section.

**DO NOT** store any combustible materials, gasoline, and any other flammable vapors/liquids in the vicinity of the unit. Provide adequate clearance for servicing and operation.

# UTILISATION SÛRE ET ENTRETIEN DES CYLINDRES DE GAZ DE PROPANE

## IMPORTANT POUR VOTRE SÛRETÉ

### LISEZ ET SUIVEZ TOUS LES AVERTISSEMENTS ÉQUIPÉS DE VOTRE CYLINDRE DE GAZ DE PROPANE.

En actionnant cet appareil avec un cylindre de gaz de propane ON DOIT observer ces instructions et avertissements.

**LE MANQUE DE FAIRE AINSI PEUT AVOIR COMME CONSÉQUENCE UNE INCENDIE OU UNE EXPLOSION SÉRIEUSE.**

## CYLINDRE ET CONDITIONS ET CARACTÉRISTIQUES DE CONNECTEUR

- Des cylindres et les valves de gaz de propane doivent être maintenus en bon état et doivent être remplacés s'il y a des dommages évidents au cylindre ou à la valve.
- Ce unité, une fois utilisé avec un cylindre, devrait être relié à un gallon de la norme 5 (20lb.) cylindre de gaz de propane équipé d'un OPD (remplissez au-dessus du niveau le dispositif d'empêchement). L'OPD a été exigé sur tous les cylindres vendus depuis octobre 1.1998 pour empêcher le remplissage excessif.
- Les dimensions de cylindre devraient être approximativement 12" (30.5cm) de diamètre et 18" (45.7cm) hauts. Des cylindres doivent être construits et marqués selon les caractéristiques pour des cylindres de gaz de propane du département des ETATS-UNIS du transport (D.O.T.) ou le niveau national du Canada, du CAN/CSA-B339, des cylindres, des sphères et des tubes pour le transport des marchandises dangereuses.
- Le cylindre doit inclure un collier pour protéger la valve de cylindre et le circuit d'alimentation de cylindre doit être assuré le retrait de vapeur.
- Le régulateur de pression et l'ensemble de tuyau utilisé doivent assortir les spécifications pour le type I par ANSI Z 21.58/CGA 1.6 (voir la figue. 6-1).
- La valve de cylindre de gaz de propane doit être équipée d'un dispositif d'accouplement de raccordement de cylindre, décrit comme type I dans la norme définie dans le e. de paragraphe ci-dessus. Ce dispositif est généralement décrit comme coupleur rapide de fil de point culminant.
- Si votre cylindre de gaz de propane vient avec une prise de la poussière, placez le bouchon anti-poussière sur la sortie de valve de cylindre toutes les fois que le cylindre n'est pas en service.

## OPÉRATION DE COUPLEUR RAPIDE

**Pour relier le regulator/hose à l'ajustage de précision de valve de cylindre de gaz de propane:** Serrez l'écrou de main sur le régulateur au-dessus de l'ajustage de précision de fil de point culminant sur la valve de cylindre. Tournez l'écrou de

main dans le sens des aiguilles d'une montre pour engager les fils et pour serrer jusqu'à ce que douillettement. L'utilisation des pinces ou de la clé ne devrait pas être nécessaire. Seulement le propane marqué par cylindres doit être employé.

**Pour débrancher:** Tournez l'écrou de main dans le sens contraire des aiguilles d'une montre jusqu'à isolé (fig. 6-1).

**Important:** Avant d'employer le unité, et ensuite chaque fois que le cylindre est enlevé et rattaché, examinez tous les raccordements pour déceler les fuites. Arrêtez les valves de unité et ouvrez la valve principale de cylindre, puis vérifiez les raccordements avec de l'eau savonneux. Réparez toutes les fuites avant d'allumer le unité.

**ATTENTION:** Tournez toujours la valve principale de cylindre de propane au loin après chaque utilisation, et avant de déplacer le unité et le cylindre, ou débrancher l'accouplement. Cette valve doit rester fermée et le cylindre a débranché alors que l'appareil n'est pas en service, quoique l'écoulement de gaz soit arrêté par un dispositif de sûreté quand le coupleur est débranché.

**Inspectez soigneusement** l'ensemble de tuyau chaque fois avant que le gaz soit allumé. Un tuyau fissuré ou effiloché doit être immédiatement remplacé.

Si l'appareil est stocké à l'intérieur, le cylindre doit être disconnected et a enlevé. Des cylindres Disconnected doivent être stockés dehors, hors de la portée des enfants, avec les prises de valve filettées étroitement installées, et ne doivent pas être stockés dans un bâtiment, le garage, ou n'importe quel autre secteur inclus.

## POUR VOTRE SÛRETÉ

- Ne stockez pas un cylindre de gaz disponible de propane dessous ou ne vous approchez pas de cet appareil.
- Ne remplissez jamais cylindre au delà de 80 pour cent de plein.
- SI L'INFORMATION DANS "A" ET "B" N'EST PAS SUIVIE EXACTEMENT, UN FEU CAUSANT LA MORT OU DES DOMMAGES SÉRIEUX PEUT SE PRODUIRE.

**Fig. 6-1 type coupleur rapide de fil de point culminant d'I**

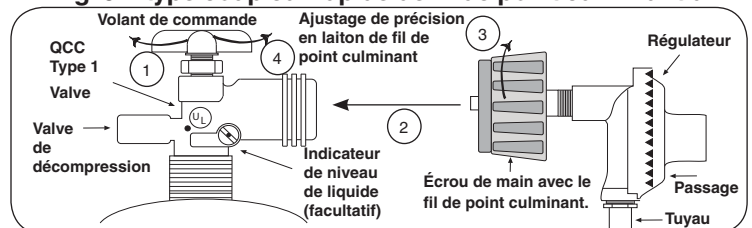

**Pour les besoins de ventilation et d'enceinte au propane,  
Voir la section ENCLOSURE / VENTILATION REQUIREMENTS.**

# SAFE USE & MAINTENANCE OF PROPANE GAS CYLINDERS

## IMPORTANT FOR YOUR SAFETY

### READ AND FOLLOW ALL WARNINGS PROVIDED WITH THE PROPANE-GAS CYLINDER.

When operating this appliance with a propane-gas cylinder, these instructions and warnings **MUST** be observed.

**FAILURE TO DO SO MAY RESULT IN A SERIOUS FIRE OR EXPLOSION.**

## CYLINDER/CONNECTOR REQUIREMENTS

- Propane-gas cylinders, valves, and hoses must be maintained in good condition and must be replaced if there is visible damage to either the cylinder or valve. If the hose is cut or shows excessive abrasion or wear, it must be replaced before using the gas appliance (see e.).
- This unit, when used with a cylinder, should be connected to a standard 5-gallon (20 lb.) propane-gas cylinder equipped with an OPD (Overfill Prevention Device). The OPD has been required on all cylinders sold since October 1, 1998, to prevent overfilling.
- Cylinder dimensions should be approximately 12" (30.5 cm) in diameter and 18" (45.7 cm) high. Cylinders must be constructed and marked in accordance with the *Specifications for Propane Gas Cylinders of the U.S. Department of Transportation (D.O.T.)* or the National Standard of Canada, *CAN/CSA-B339, Cylinders, Spheres, and Tubes for Transportation of Dangerous Goods*.
- The cylinder used must include a collar to protect the cylinder valve, and the cylinder supply system must be arranged for vapor withdrawal.
- The pressure regulator and hose assembly used must match the specification for Type I by *ANSI Z 21.58/CGA 1.6* (see Fig. 7-1).
- The propane-gas cylinder valve must be equipped with a cylinder connection coupling device, described as Type I in the standard defined in paragraph e. above. This device is commonly described as an Acme thread quick coupler.
- If the propane-gas cylinder comes with a dust plug, place the dust cap on the cylinder valve outlet whenever the cylinder is not in use.

## QUICK COUPLER OPERATION

**To connect the regulator/hose assembly to the propane-gas cylinder valve fitting:** Press the hand nut on the regulator over the Acme thread fitting on the cylinder valve. Turn the hand nut clockwise to engage the threads and tighten until snug.

The use of pliers or a wrench should not be necessary. Only cylinders marked "propane" may be used.

**To disconnect:** Turn the hand nut counterclockwise until detached (Fig. 7-1).

**Important:** Before using the unit, and after each time the cylinder is removed and reattached, check the hose for wear (see a.) and check all connections for leaks. Turn off the unit valves and open the main cylinder valve, then check connections with soapy water. Repair any leaks before lighting the unit.

**CAUTION:** Always turn the propane cylinder main valve off after each use, and before moving the unit and cylinder or disconnecting the coupling. This valve must remain closed and the cylinder disconnected while the appliance is not in use, even though the gas flow is stopped by a safety feature when the coupler is disconnected.

**Carefully** inspect the hose assembly each time before the gas is turned on. A cracked or frayed hose must be replaced immediately.

If the appliance is stored indoors, the cylinder must be disconnected and removed. Disconnected cylinders must be stored outdoors, out of the reach of children, with threaded valve plugs tightly installed, and must not be stored in a building, garage, or any other enclosed area.

## FOR YOUR SAFETY

- DO NOT store a spare propane-gas cylinder under or near this appliance.
- NEVER fill the cylinder beyond 80-percent full.
- IF THE INFORMATION IN a. AND b. IS NOT FOLLOWED EXACTLY, A FIRE CAUSING DEATH OR SERIOUS INJURY MAY OCCUR.

Fig. 7-1 Type I Acme thread quick coupler

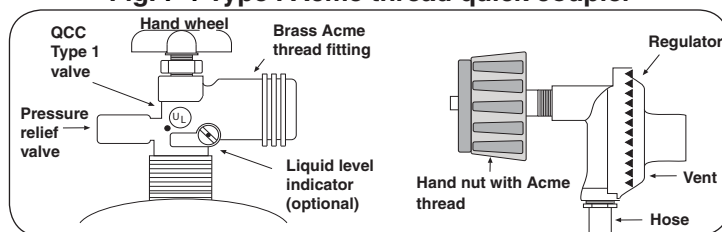

**For propane ventilation and enclosure requirements,  
see the ENCLOSURE / VENTILATION REQUIREMENTS section.**

## ENCLOSURE / VENTILATION REQUIREMENTS

Fire Magic GFRC islands are available. They meet all enclosure and ventilation requirements. For requirements regarding custom-built enclosures, see below.

### VENTILATION (ALL ENCLOSURES)

**For All Piping Systems and All Gas Types:**  
(Natural Gas, Household Propane, L.P. Cylinder)

**FOR YOUR SAFETY, you must provide the openings listed below for replacement air and ventilation of the enclosure (in case of possible leakage from gas connections or L.P. cylinders). Failure to do so may result in a fire or explosion causing property damage, bodily injury, or death.**

**One side of the enclosure shall be left completely open to the outside; OR 4 (minimum) ventilation openings MUST be created (reference Fig. 8-1 and Fig. 8-2):**

- **Each opening must have a minimum of 10 sq. in. of free area. The openings must be equally sized. (Total of 40 sq. in. free area.)**
- Two openings must be in the side walls of the enclosure, at the top level, and spaced at a minimum of 90 degrees. The openings must begin 1" or less below the countertop level and end no more than 5" below the countertop level.
- Two openings must be in the side walls of the enclosure, at the floor level, and spaced at a minimum of 90 degrees. The openings must begin 1" or less above the floor level and end no more than 5" above the floor level.
- **The openings must remain unobstructed:**

The clearance between the openings and any items outside of the enclosure is a minimum of 6". The clearance between the openings and any items within the enclosure is a minimum of 2". See Fig. 8-2.

**When an L.P. cylinder is used in the enclosure, additional requirements exist, see the following section.**

It is acceptable to use RHP venting panels (PN 5510-01). Contact your dealer.

**KEEP THE REQUIRED VENT OPENINGS AND SURROUNDING AREA OF THE ENCLOSURE CLEAR AND FREE AT ALL TIMES.**

**WARNING:** Ventilation openings in side walls shall not communicate directly with other enclosures of the outdoor cooking gas appliance.

**When installing this unit in a combustible enclosure, the correct air gap requirement must be met.**

#### Ventilation Requirements:

- Minimum 4 openings  
(2 per side wall - spaced at min. 90 degrees)
- Top openings: within 5" of countertop (see below)
- Bottom openings: within 5" of floor (see below)
- Each vent opening: min. 10 sq. in. of free area  
(Total = 40 sq. in. free area)

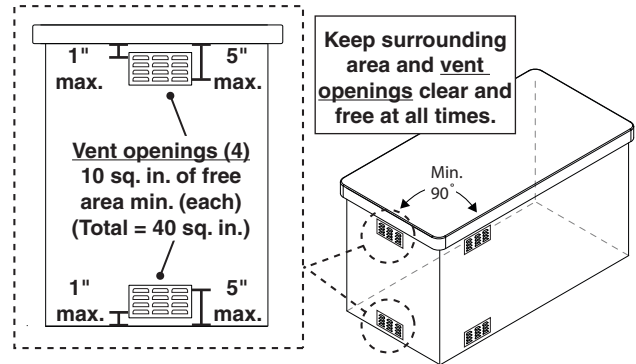

Note: Vent openings example shown. Your design may vary.

Fig. 8-1 Ventilation detail

- 6" min. clearance between all vent openings and any items outside of enclosure
- 2" min. clearance between all vent openings and any items within enclosure

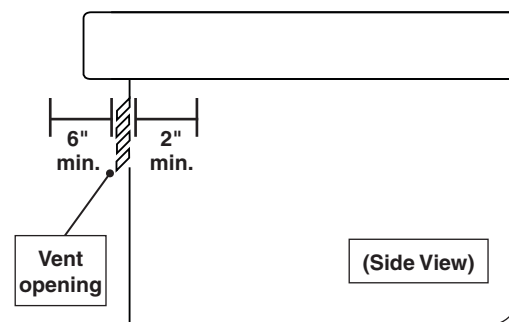

Fig. 8-2 Vent openings clearance



## ENCLOSURE / VENTILATION REQUIREMENTS (cont.)

### WHEN A PROPANE (L.P.) CYLINDER IS USED IN THE ENCLOSURE

When a propane (L.P.) cylinder is installed inside of the enclosure, the additional guidelines below **MUST** be followed. FAILURE TO DO SO MAY CAUSE DAMAGE TO YOUR UNIT AND/OR PERSONAL INJURY. Reference Fig. 9-1 and 9-2 for an example.

- Only a C.S.A. listed stainless steel connector can be connected to the unit.
- The regulator/hose assembly coming from the cylinder can only be connected to the above mentioned flex connector. **DO NOT connect the regulator/hose assembly directly to the unit.** An adapter will be required.
- A non-combustible heatshield must be installed to protect the regulator/hose assembly and cylinder valve.
- The cylinder must rest at least 2" above the ground.
- An additional vent opening is recommended in the access door near the cylinder and at the gas connection level (minimum 10 sq. in. of free area).

RHP offers an "access door with tank tray and louvers" which includes a heatshield that rests directly above the L.P. cylinder, a tray, and louvers to meet the cylinder install requirements. The door is shown in Fig. 9-3. Contact your dealer for ordering information.

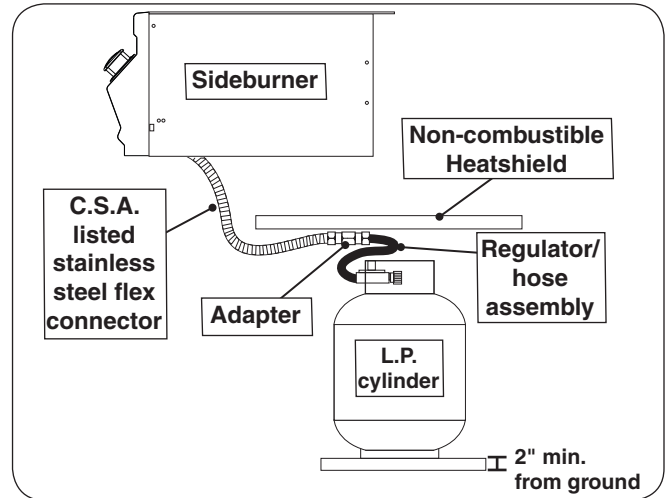

Fig. 9-1 L.P. cylinder orientation

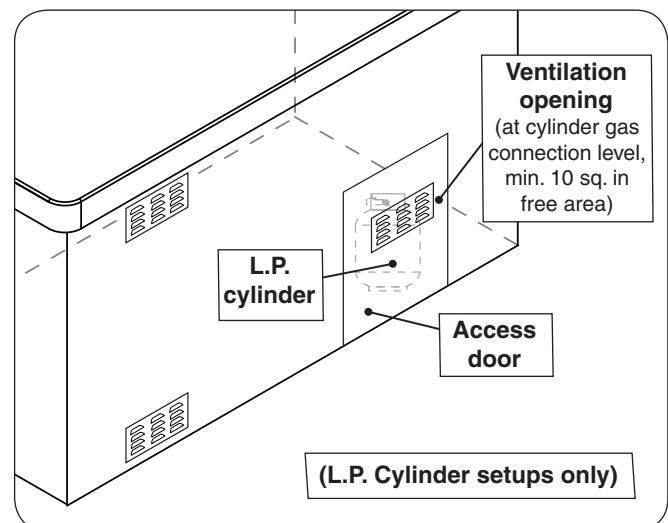

Fig. 9-2 Additional ventilation opening for L.P. cylinder

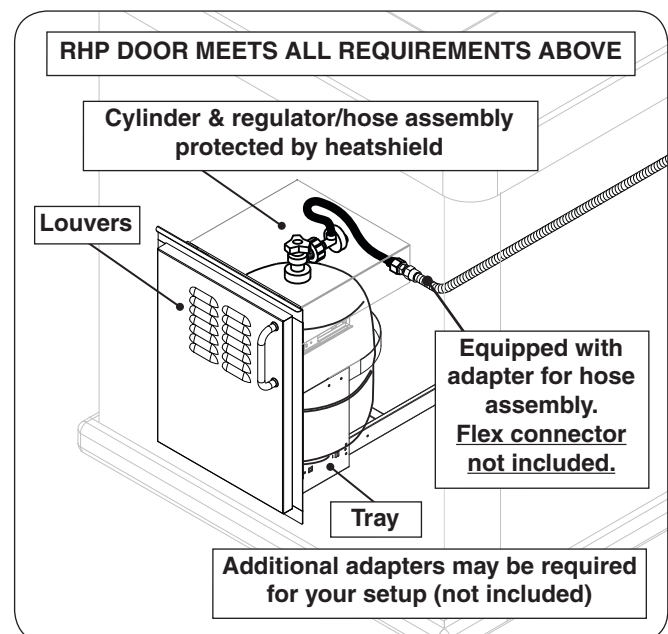

Fig. 9-3 Optional door w/ tank tray & louvers

## INSTALLATION REQUIREMENTS

Installation must be performed by a qualified professional service technician.

This unit is designed for outdoor use only. **DO NOT** use this unit inside a building, garage, or enclosed area. **DO NOT** use this unit in or on a recreational vehicle or boat.

### OVERHEAD CONSTRUCTION REQUIREMENTS

A minimum 5 foot clearance is required between the countertop and the overhead construction.

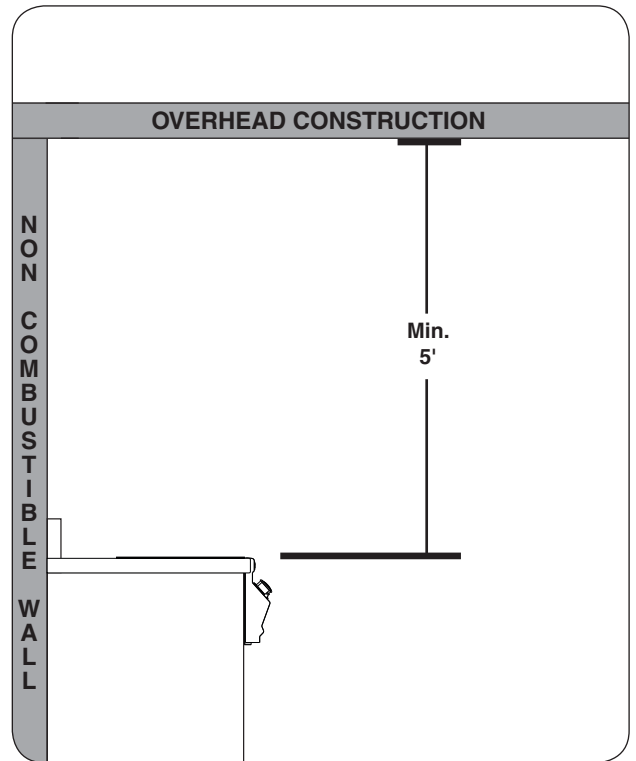

Fig. 10-1 Overhead requirements

## SIDE AND REAR WALL CLEARANCES

For the minimum clearances between the unit and any side or rear walls, your setup must fall within one (or more) of the following:

### A. Clearance between unit and strictly non-combustible wall

(i.e. brick wall, see Fig. 11-1)

- The unit must have a minimum of 4" right, left, and rear clearance from any non-combustible wall.

(To allow for proper ventilation and prevent dangerous overheating.)

### B. Clearance between unit and a protected combustible wall

(i.e. a non-combustible wall in front of a combustible wall to serve as a barrier. This can be accomplished by brick, or a metal stud finished with non-combustible substrate, see Fig. 11-2)

- The unit must have a minimum of 14" right, left, and rear clearance from the protected combustible wall.

(The 4" non-combustible material plus an additional 10" clearance between the unit and protected wall.)

### C. Clearance between unit and combustible wall

- The unit must have a minimum of 18" right, left, and rear clearance from any combustible wall (see Fig. 11-3).

## BACKSPLASH CLEARANCE (if applicable)

If a non-combustible backsplash exists, it must have a minimum of a 4" clearance from the rear of the unit (to allow for proper ventilation and prevent dangerous overheating). See Fig. 11-4.

**Important:** This 4" backsplash clearance must first be met prior to any non-combustible walls beginning behind it.

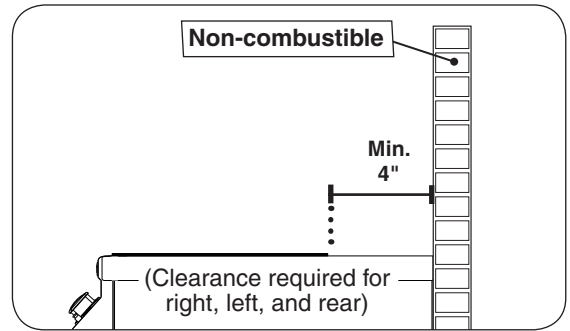

**Fig. 11-1** Clearance 'A' Diagram

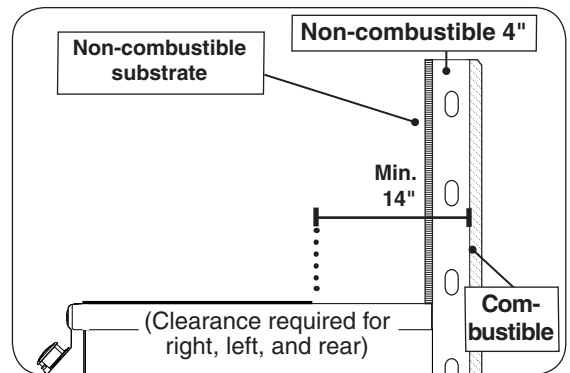

**Fig. 11-2** Clearance 'B' Diagram

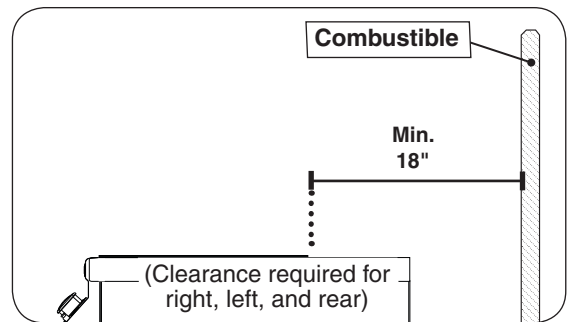

**Fig. 11-3** Clearance 'C' Diagram

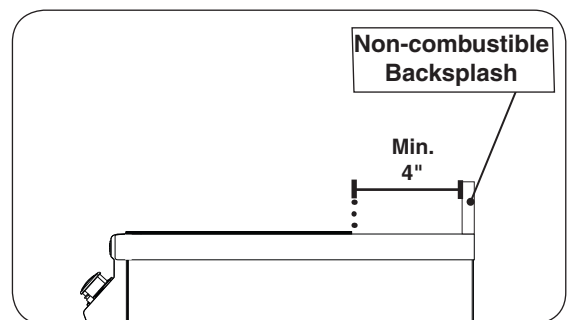

**Fig. 11-4** Backsplash clearance

## INSTALLATION REQUIREMENTS (Cont.)

The control panel **MUST** remain removable for servicing (see CONTROL PANEL REMOVAL section).

### COMBUSTION AIR AND COOLING AIRFLOW

Proper airflow (front-to-back, Fig. 12-1) **MUST** be maintained for the unit to perform as it was designed. If airflow is blocked, overheating and poor combustion will result. Do not block the 1" front air inlet along the bottom of the control panel.

### GAS-SUPPLY PLUMBING REQUIREMENTS

For natural gas or a household propane system, rigid  $\frac{1}{2}$ " or  $\frac{3}{4}$ " black steel pipe or local code-approved pipe is required to conduct the gas supply to the unit. Contact your local gas supplier. Connect this pipe to the required C.S.A.-approved stainless-steel flex connector (attached). An NPT adapter has been provided for  $\frac{1}{2}$ " pipe. **DO NOT use a rubber hose within the unit enclosure.** Apply only joint compounds that are resistant to all gasses to all male pipe fittings except flare fittings. Make sure to tighten every joint securely.

**Note:** If  $\frac{1}{2}$ " pipe is used with **natural gas**, it should be no longer than 20'.

**Important:** A **shut-off valve (not included) in the gas line is required.** It provides for safety when the unit is not in use and for convenient maintenance and repair. It must be installed within 6 feet of the unit. Use a pipe joint compound resistant to all gasses on all male fittings except flare fittings.

### GAS SUPPLY AND MANIFOLD PRESSURES:

For **natural gas** - normal 7" water column (w.c.), minimum 5", maximum 10  $\frac{1}{2}$ ". For **propane gas** - normal 11" w.c., minimum 10", maximum 13".

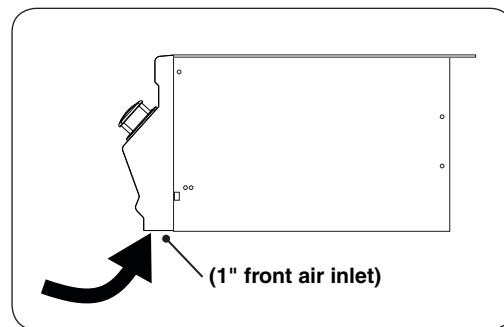

Fig. 12-1 Airflow diagram

## ELECTRICAL SAFETY

- To protect against electric shock, do not immerse cord or plugs in water or other liquid.
- Unplug from the outlet when not in use and before cleaning. Allow to cool before putting on or taking off parts.
- Do not operate any outdoor cooking gas appliance with a damaged cord, plug, or after the appliance malfunctions or has been damaged in any manner. Contact the manufacturer for repair.
- Do not let the cord hang over the edge of a table or touch hot surfaces.
- Do not use an outdoor cooking gas appliance for purposes other than intended.
- When connecting, first connect plug to the outdoor cooking gas appliance then plug appliance into the outlet.
- **Use only a properly wired and inspected 120VAC (15 AMP minimum) Ground Fault Circuit Interrupter (GFCI) GROUNDED 3-wire receptacle with this outdoor cooking gas appliance.**
- The GFCI receptacle must be a WEATHER-PROOF IN-USE COVERED RECEPTACLE.
- Never remove the grounding plug or use with an adapter of 2 prongs.
- Use only extension cords with a 3 prong grounding plug, rated for the power of the equipment, and approved for outdoor use with a W-A marking.
- **The provisions of the National Electric Code as well as any local codes must be observed when installing the product.**

## MODEL SPECIFICATIONS

	<b>Double Sideburner 3281(P)L</b>	<b>Single Sideburner 3279(P)L-1</b>
Main burner quantity N/P orifice drill size	2 #51 / #58	1 #51 / #58
Input electrical requirements	120VAC / 15 AMP minimum / 60 Hz / GFCI outlet	
Electrical output	12 VAC / 36 Watts 12 VDC / 36 Watts	

**Table 1 - Product Specifications**

	<b>Height</b>	<b>Width</b>		<b>Depth</b>
	(Top to bottom)	(Left to right)		(Front to back)
	Top of hanger to bottom of unit <b>(A)</b>	Hanger to hanger <b>(B)</b>	Control panel width <b>(C)</b>	Maximum depth <b>(D)</b>
<b>Double Sideburner</b>	12"	15 1/2"	12 1/8"	28.5"
<b>Single Sideburner</b>	12"	15 1/2"	12 1/8"	20"

**Table 2 - Dimensions**

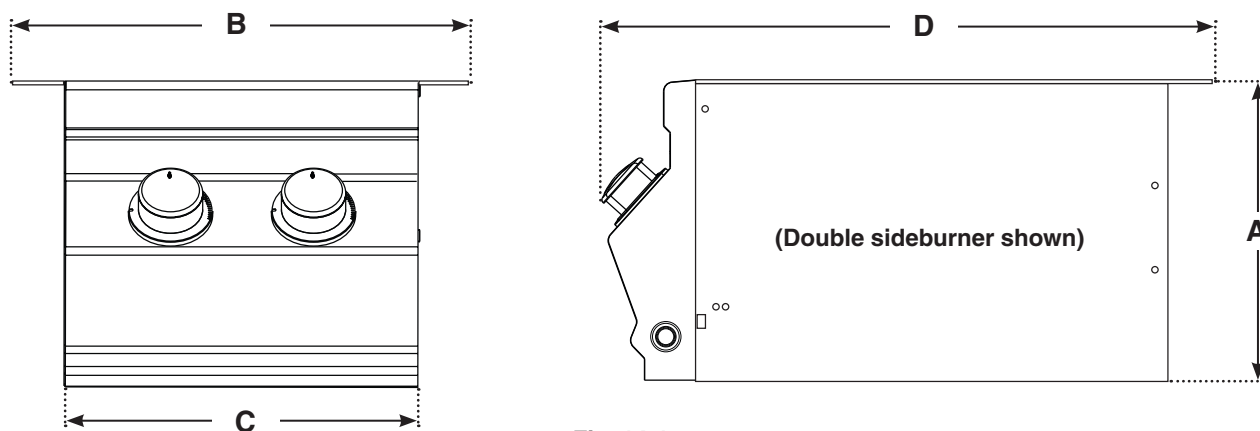

**Fig. 14-1**

## MODEL SPECIFICATIONS (cont.)

	Double Sideburner		Single Sideburner	
	Non-combustible enclosures	Combustible enclosures	Non-combustible enclosures	Combustible enclosures
<b>A</b> Countertop to unit bottom <b>cut-out</b>	12"	12"	12"	12"
<b>B</b> Side to side <b>cut-out</b>	11-1/2"	12" <sup>▲</sup>	11-1/2"	12" <sup>▲</sup>
<b>C</b> Front to back <b>cut-out</b> †	22-3/4"	23-1/4" <sup>▲</sup>	14"	14-1/2" <sup>▲</sup>
<b>D</b> Control panel width <b>cut-out</b> ‡	12-5/8"	12-5/8"	12-5/8"	12-5/8"

▲ The increased dimensions for combustible enclosures allow for a required air gap along the sides and rear of the unit. See the COMBUSTIBLE ENCLOSURE CUT-OUT section on the next page for details.

† Includes any substrate at front wall of enclosure (in the area the rear of the control panel is to sit flush against). See SUBSTRATE section on next page.

‡ Only applicable for enclosures that have countertops with an overhang (see illustration and section below).

**Table 3 - Cutout Dimensions**

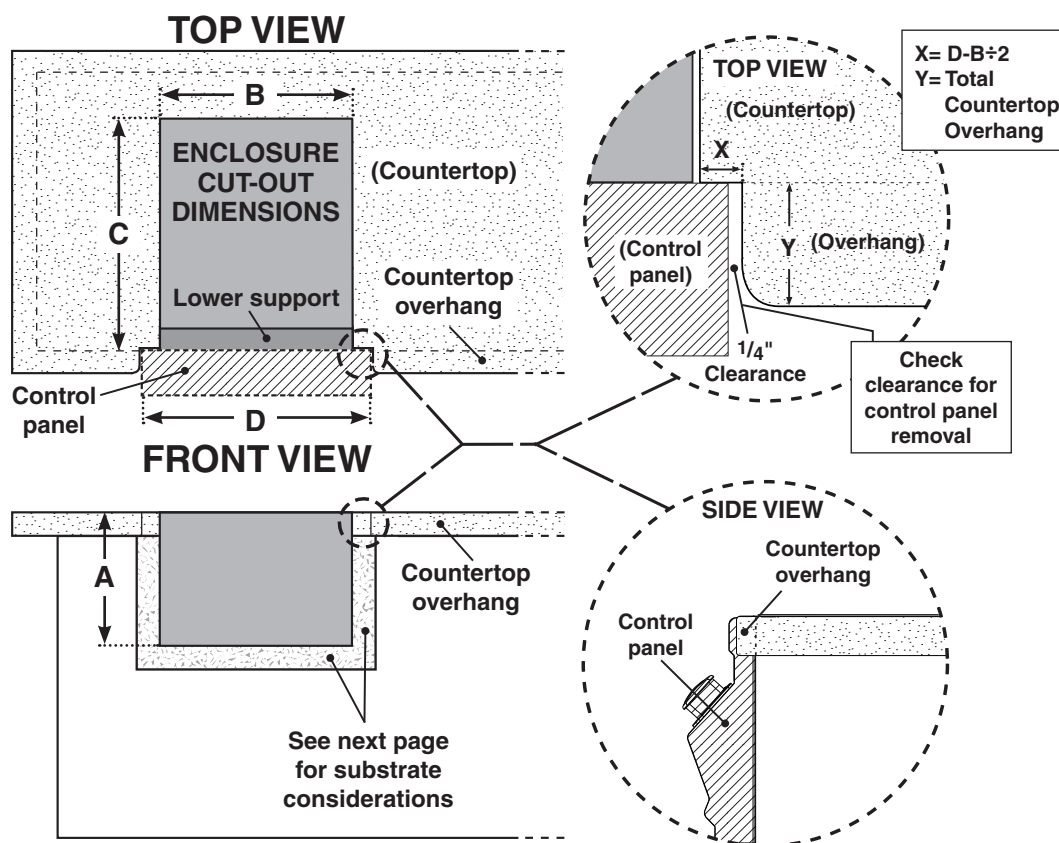

Fig. 15-1

### COUNTERTOP OVERHANG

The control panel is designed to sit flush against the enclosure front wall. If the enclosure countertop extends beyond the front wall, creating a countertop overhang, it must be cut flush with the front wall for the width of the control panel or a gap will be created exposing the forward portions of the left and right side fire walls of the unit. See illustrations above.

### ENCLOSURE VENTILATION

**FOR YOUR SAFETY**, you must provide openings in the enclosure for replacement air and ventilation (in case of possible leakage from gas connections or propane cylinders). Failure to do so may result in a fire or explosion causing property damage, bodily injury, or death. See the ENCLOSURE / VENTILATION REQUIREMENTS section for details.

**COMBUSTIBLE ENCLOSURE CUT-OUT**

This unit may be installed into combustible framing (wood, for instance) provided there is a minimum of a 1/2" airspace between ALL sides of the unit and any combustible material.

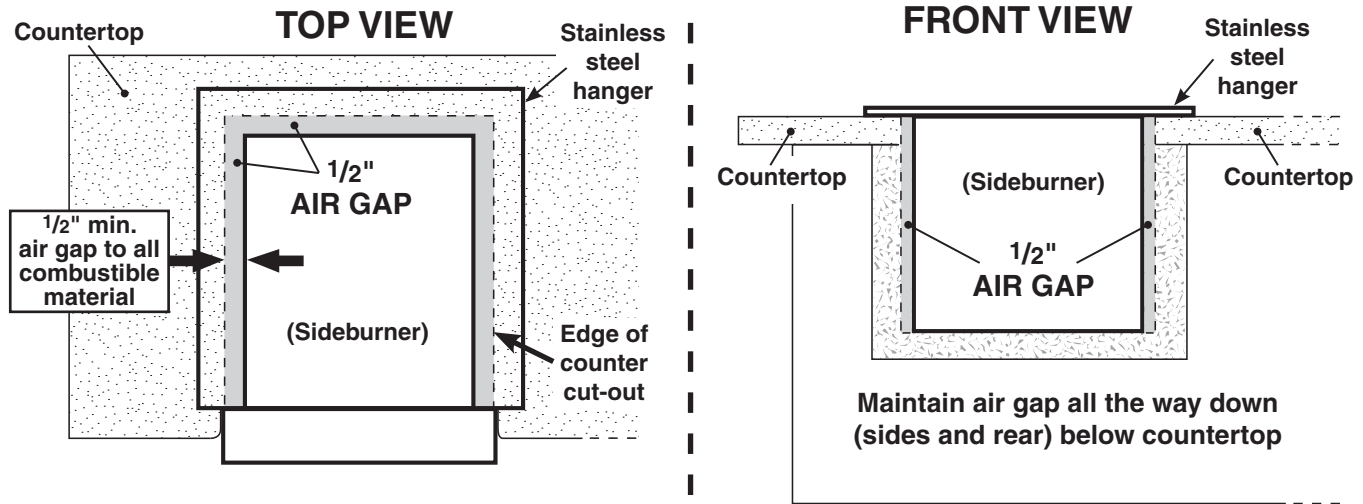

Fig. 16-1

**SUBSTRATE**

When adding any substrate to the enclosure front wall (including tiles, stone, etc.), consider the following:

**Substrate Behind Control Panel**

Substrate + countertop "front to back" cutout must equate to **Dim. C** (see previous page) when the substrate sits flush behind the control panel.

**Substrate Alongside Control Panel**

Any additional substrate alongside the control panel does not need to be considered in **Dim. C** (see previous page), however a 1/4" clearance on each side (same as overhang) and below is required.

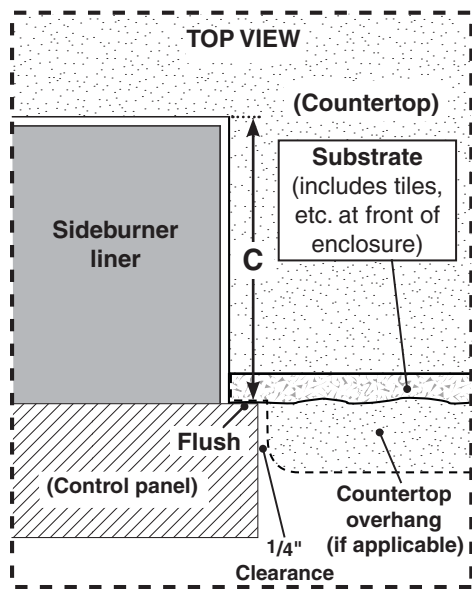

Fig. 16-2

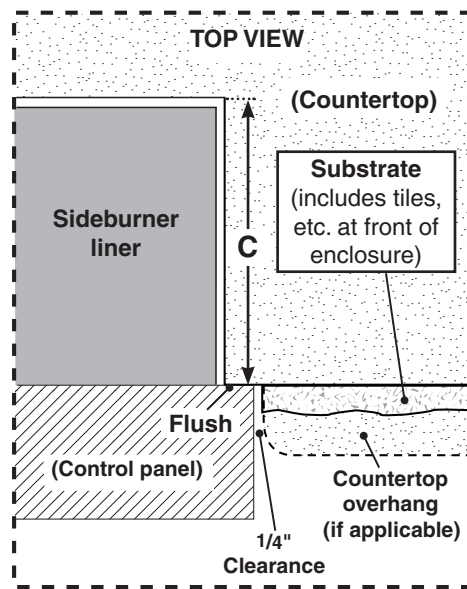
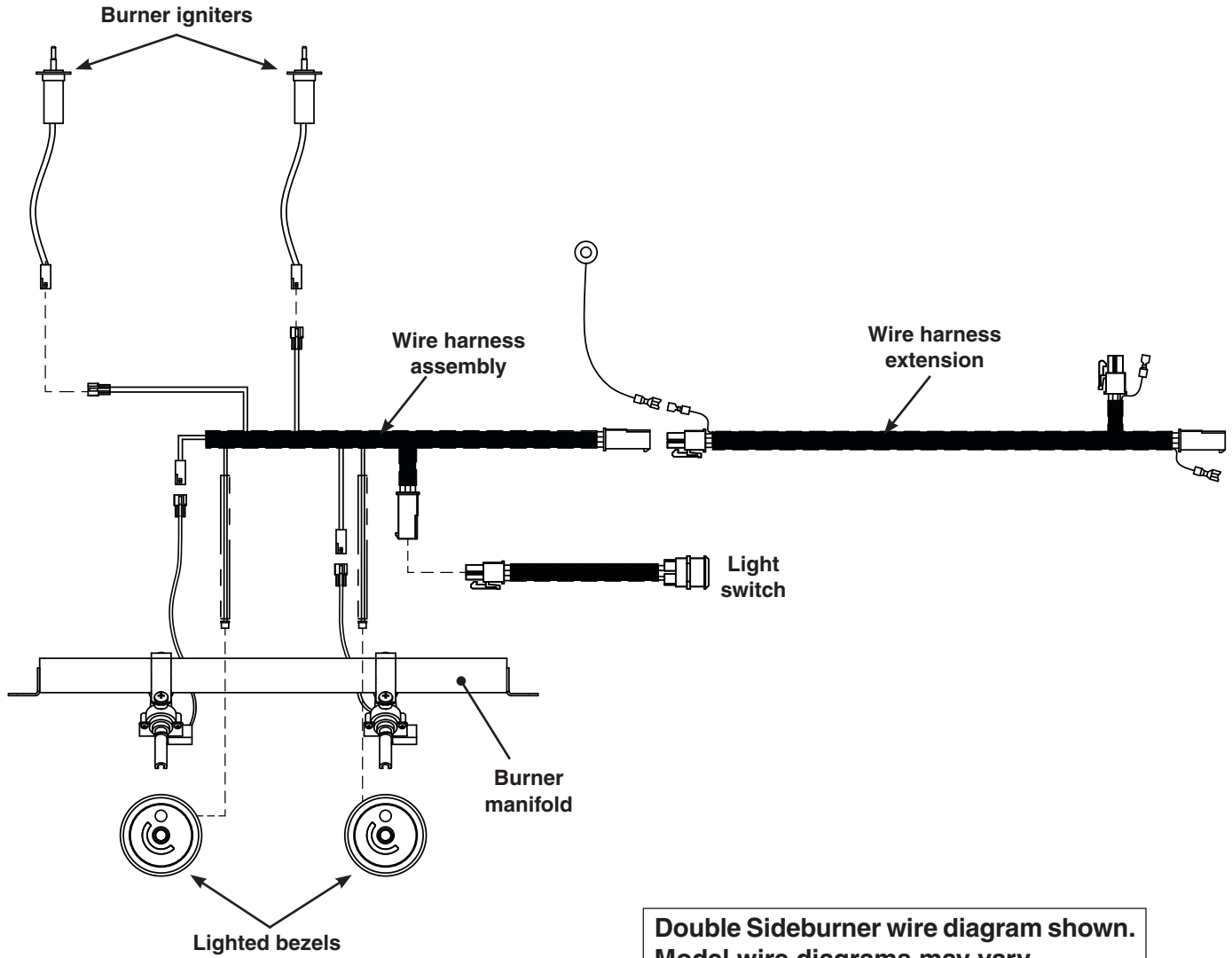

Fig. 16-3



WIRING DIAGRAM



Double Sideburner wire diagram shown.  
Model wire diagrams may vary.

Note: In addition, a wire diagram specific to your unit can be found affixed to the inside of the control panel.

# REPLACEMENT PARTS LIST

		Double Sideburners 3281 Series		Single Sideburners 3279 Series	
Item	Description	Part No.	Qty.	Part No.	Qty.
1.	Sideburner lid	3281-07	1	3279-07	1
2.	Porcelain cast iron cooking grid	3529	1	3550	1
or	Stainless steel cooking grid	3529-S	1	3550-S	1
3.	Burner assembly (w/ burner pipe)	3279-32	2	3279-32	1
4.	Burner cap (only)	3279-36	2	3279-36	1
5.	Control panel	23281-07	1	23279-07	1
6.	Valve manifold assembly	3281-22	1	3279-22	1
7.	Burner igniter	3199-72	2	3199-72	1
8.	Control knob	24182-42	2	24182-42	1
9.	Light bezel assembly	24182-64	2	24182-64	1
10.	Convertible Regulator	PR-4	1	PR-4	1
11.	Natural gas orifice ‡	3001-51-1	2	3001-51-1	1
or	Propane gas orifice ‡	3001-58-1	2	3001-58-1	1
12.	Wire harness assembly ‡	24182-57	1	24182-58	1
13.	Wire harness extension ‡	24182-55	1	24182-55	1
14.	Flex connector w/ fittings ‡	3031	1	3031	1
15.	Power supply w/ connector * ‡	24177-12	1	24177-12	1
16.	Light switch	24182-48	1	24182-48	1

‡ Not shown

\* Optional / purchased separately

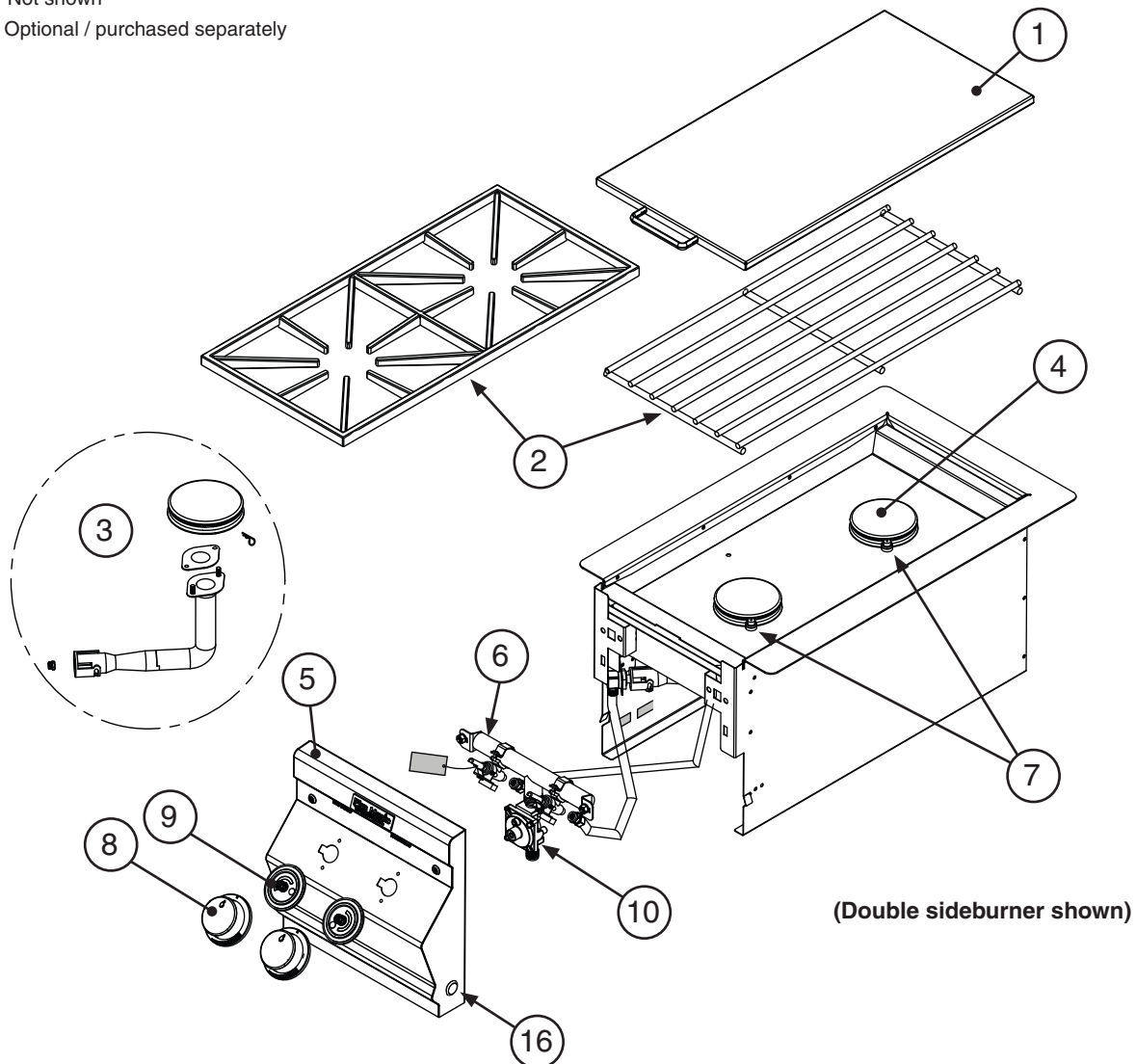

## INSTALLATION

It is not required to remove the control panel or knobs to install this unit.

**DO NOT** lift the unit from the control panel when installing.

### COUNTER PREPARATION

Consult Table 3 for enclosure cut-out dimensions. If the counter or any supporting construction is combustible, the COMBUSTIBLE ENCLOSURE CUT-OUT section must be followed before beginning the installation.

This sideburner must be supported by the stainless-steel hanger extending from the upper portion of the frame. The hanger rests on the left, right, and back of the countertop.

The control panel is designed to sit flush against the enclosure front wall (see Fig. 19-1). If the enclosure countertop extends beyond the front wall, creating a countertop overhang (see Fig. 19-2), it must be cut flush with the front wall for the width of the control panel or a gap will be created exposing the forward portions of the left and right side fire walls of the unit. See the MODEL SPECIFICATIONS section.

### CONNECT THE GAS SUPPLY

#### For propane cylinders:

For connecting a propane unit to a portable propane tank, read the safety warnings and follow the instructions in the section SAFE USE AND MAINTENANCE OF PROPANE GAS CYLINDERS.

**Note:** When a propane cylinder is installed inside of the enclosure, the guidelines found in the ENCLOSURE / VENTILATION REQUIREMENTS section MUST be followed.

#### For household propane or natural gas units:

**CAUTION:** Use only C.S.A. listed stainless-steel flex connectors within the enclosure.

#### **WARNING**

**A rubber or plastic connector will rupture or leak, resulting in an explosion or serious injury if used inside the appliance enclosure.**

1. Locate the attached flex connector (found underneath the unit) and route it to the gas-supply stub.
2. **Turn OFF** the gas supply at the source.
3. A shut-off valve is required within 6 feet of the unit.  
***If shut-off valve is connected to end of gas supply stub:***

- Connect the flex connector to the shut-off valve (see Fig. 19-3). Tighten securely.

***If shut-off valve is installed in-line:***

- Install the supplied flare adapter to the gas supply using a pipe joint compound resistant to all gasses (see Fig. 19-3). Tighten securely.
- Connect the flex connector to the flare adapter (see Fig. 19-3). Tighten securely.

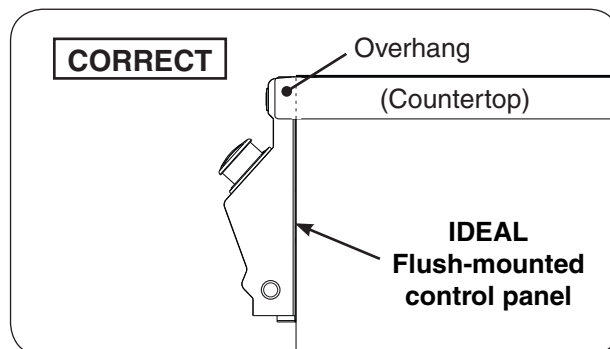

**Fig. 19-1** Countertop overhang - correct cutout

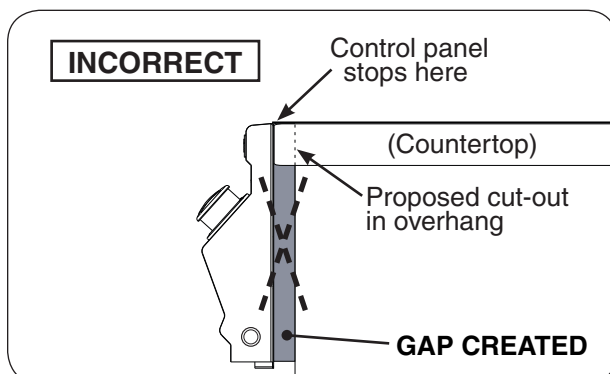

**Fig. 19-2** Countertop overhang - incorrect cutout

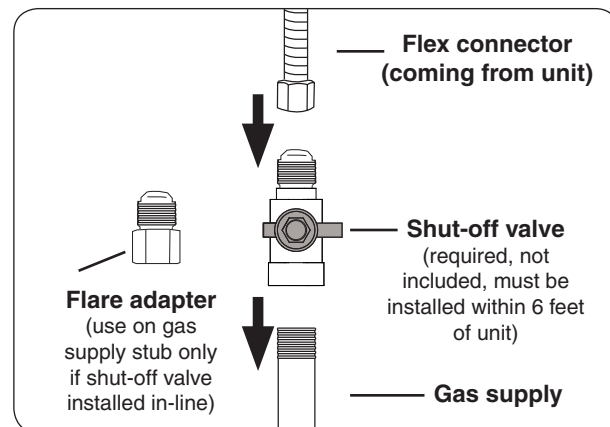

**Fig. 19-3** Connecting to a gas line

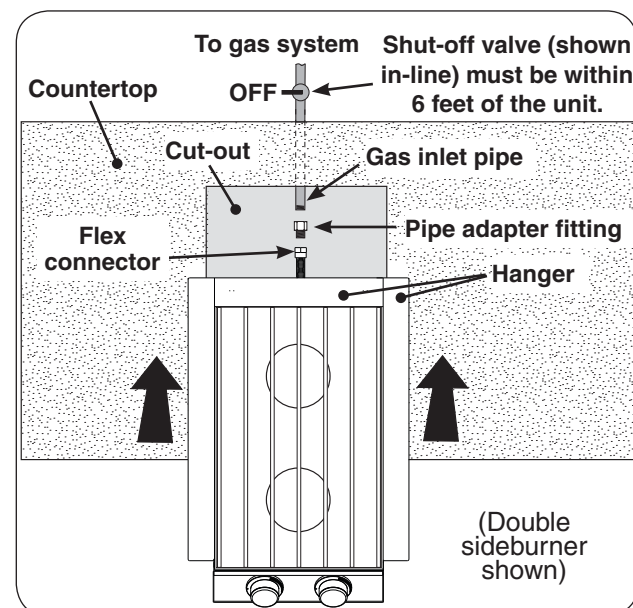

**Fig. 19-4** Household propane & nat. gas diagram

## INSTALLATION (cont.)

- Turn burner control knob(s) to the **OFF** position. Turn the gas supply on. Then carefully check *all* gas connections for leaks with a brush and half-soap/half-water solution before lighting. **NEVER USE A MATCH OR OPEN FLAME TO TEST FOR LEAKS.**
- Close the shut-off valve.

### POWER SUPPLY & WIRE HARNESS CONNECTIONS

**CAUTION:** IMPROPERLY CONNECTED WIRES WILL CAUSE DAMAGE TO THE UNIT AND MAY RESULT IN PROPERTY DAMAGE AND/OR PERSONAL INJURY.

The unit comes with a 6' wire extension to retrieve power from a separately purchased Aurora grill. Aurora grills are equipped with power supply boxes, which can supply power to the sideburner (see AURORA GRILL POWER SUPPLY BOX section below).

Alternatively; an optional power supply box may be ordered and installed to independently power this unit (see following INDEPENDENT POWER SUPPLY section). Contact your dealer for ordering information.

#### TO INSTALL USING AN AURORA GRILL POWER SUPPLY BOX:

- Locate the power supply box that is connected to the Aurora Grill and ensure the power cord is disconnected, if connected (see Fig. 20-1, A).
- Disconnect the grill wire harness extension connectors from the power supply connectors (see Fig. 20-1, B).

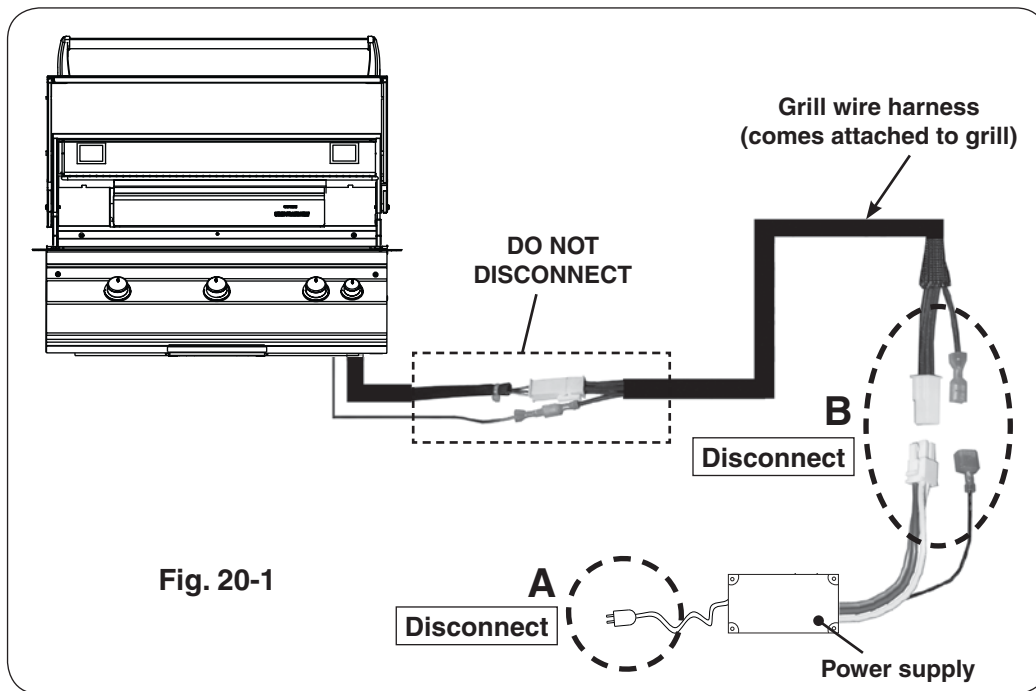

Continue to next pages for section appropriate to your setup (3A, 3B, or 3C).

## INSTALLATION (cont.)

### 3A. Single accessory connections:

- Locate the “Y” end of the wire harness extension that is included with the sideburner and make connections C and D (see Fig. 21-1, C & D).
- Connect the opposite end of the wire harness extension to the sideburner connectors (see Fig. 21-1, E).
- **Proceed to the POWER SUPPLY INSTALLATION section.**

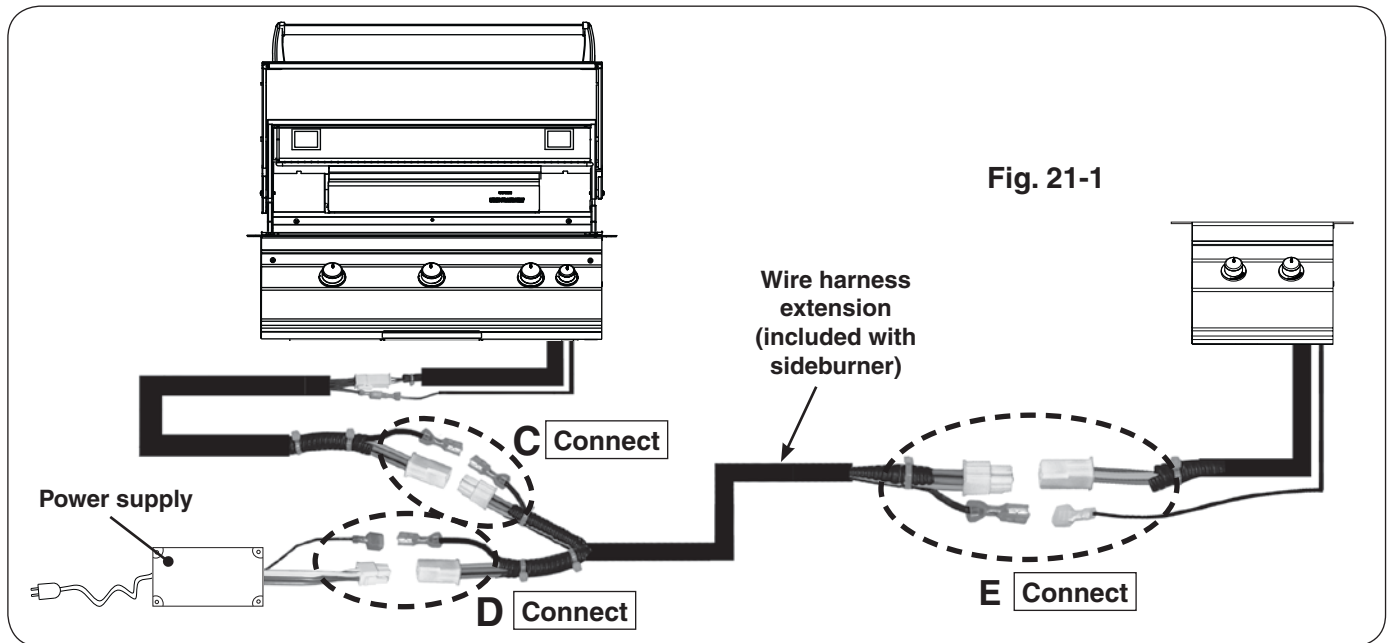

### 3B. Multiple accessory connections (grill left install):

- Locate the FIRST wire harness extension that is included with the FIRST accessory and make connections C and D (see Fig. 21-2, C & D).
- Locate the SECOND wire harness extension that is included with the SECOND accessory and make connections E, F, and G (see Fig. 21-2, E, F, & G).
- **Proceed to the POWER SUPPLY INSTALLATION section.**

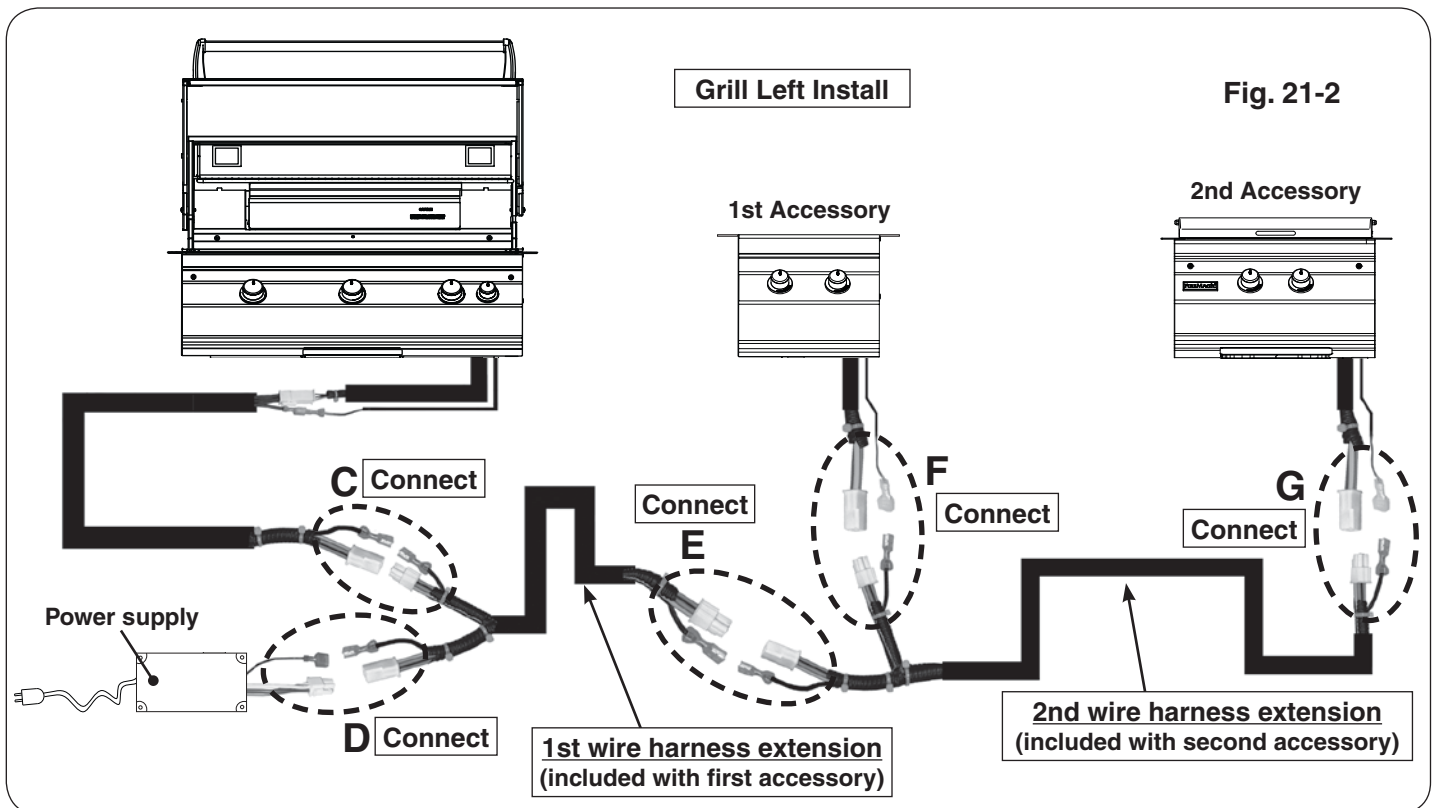

## 3C. Multiple accessory connections (grill center install):

- Locate the **FIRST** wire harness extension that is included with the **FIRST** accessory and make connections C and D (see Fig. 22-1, C & D).
- Locate the **SECOND** wire harness extension that is included with the **SECOND** accessory and make connections E, F, and G (see Fig. 22-2, E, F, & G).
- **Proceed to the POWER SUPPLY INSTALLATION section.**

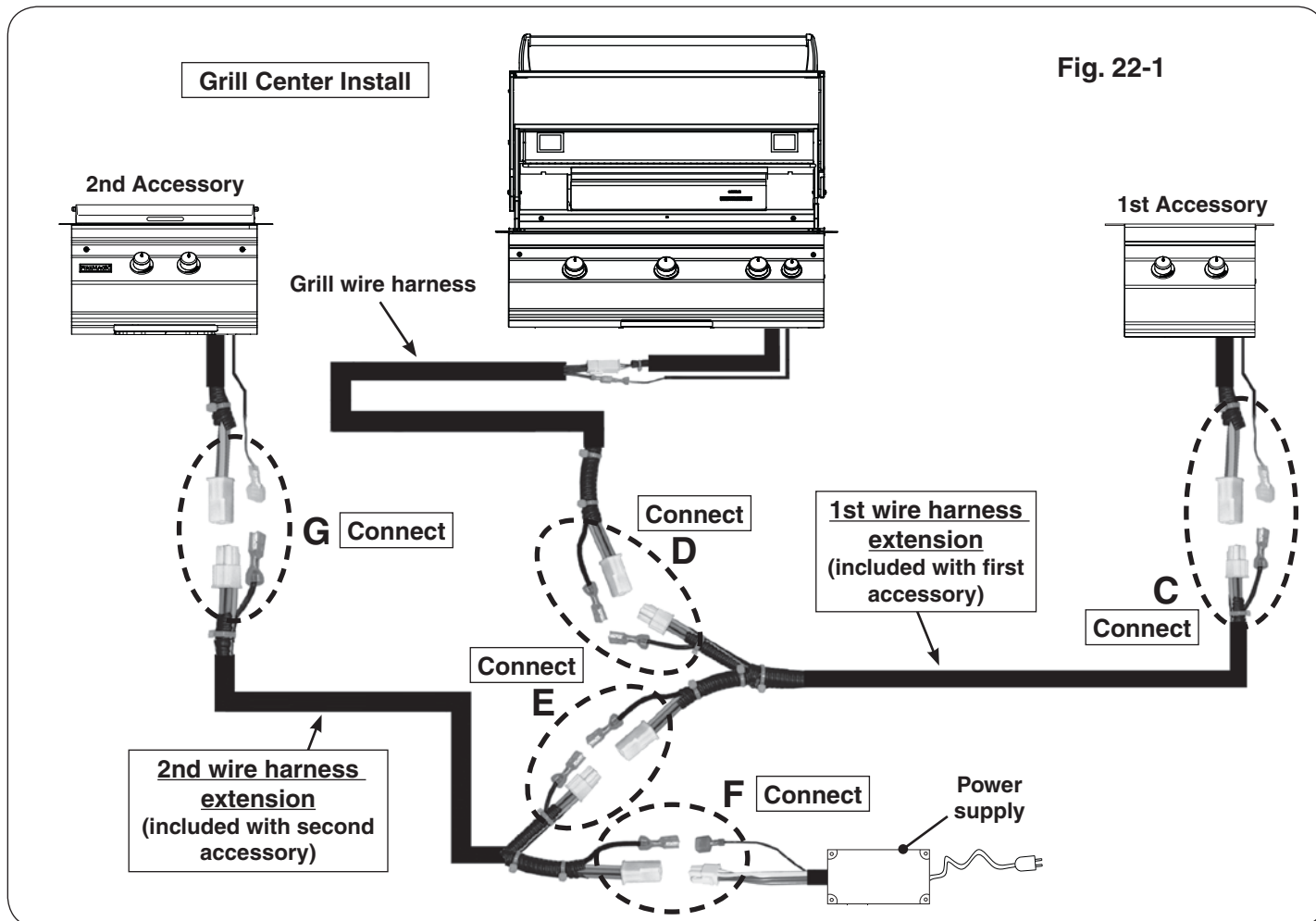

## INSTALLATION (cont.)

### TO INSTALL USING AN INDEPENDENT POWER SUPPLY BOX (NOT INCLUDED):

1. Locate the "Y" end of the wire harness extension that is included with the sideburner and connect the compatible end to the power supply connectors (see Fig. 23-1, A).
2. Connect the opposite end of the wire harness extension to the sideburner connectors (see Fig. 23-1, B).

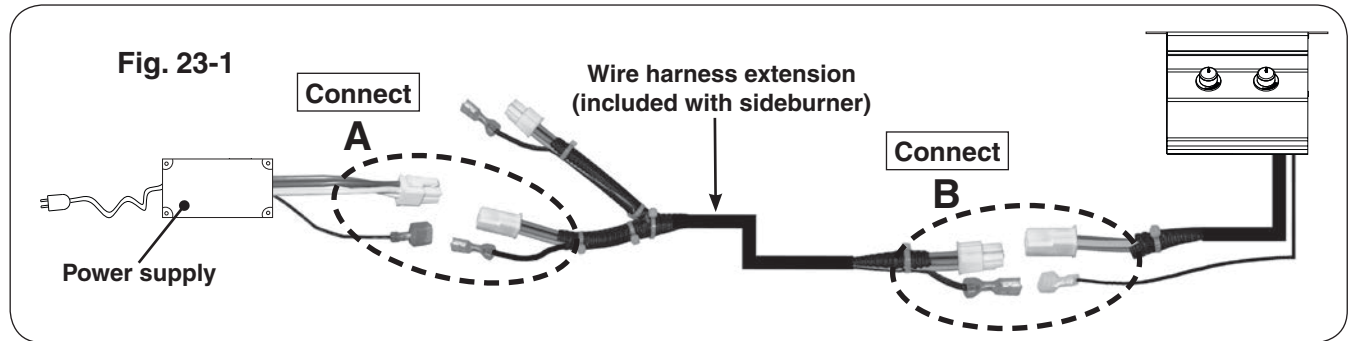

For multiple accessory connections to one independent power supply, reference the previous pages to assist with connections. (Omit the grill wire harness connection.)

### POWER SUPPLY INSTALLATION

**CAUTION:** IMPROPERLY CONNECTED WIRES WILL CAUSE DAMAGE TO THE GRILL AND/OR SIDEBURNER AND MAY RESULT IN PROPERTY DAMAGE AND/OR PERSONAL INJURY.

#### To install the power supply box:

1. It **MUST** be located at least 12 inches below the bottom of the grill and/or sideburner (see Fig. 23-2).
2. The wire extension that exits from the control panel **MUST** be routed directly downward. This will prevent overheating. **DO NOT** route the wire extension below the grill and/or sideburner (see Fig. 23-2).

**Note:** For enclosures with a solid area beneath the grill and/or sideburner, a cutout must be made near the wire extension to allow for the above requirement. If an insulating liner is installed with the grill, route the wire down through the nearest hole possible.

3. Mount the power supply box to the inside of the enclosure using appropriate hardware for your enclosure.

**WARNING:** **DO NOT** block the vent holes found on the box.

4. Connect the cord coming from the power supply to a **120VAC (15 AMP minimum) GFCI GROUNDED 3-wire receptacle** (see Fig. 23-2). The GFCI receptacle must be a WEATHER-PROOF IN-USE COVERED RECEPTACLE.

**WARNING:** **Electrical Grounding Instructions - This appliance is equipped with a three-pronged (grounding) plug for your protection against shock hazard and should be plugged directly into a properly grounded three-prong receptacle. Do not cut or remove the grounding prong from this plug.**

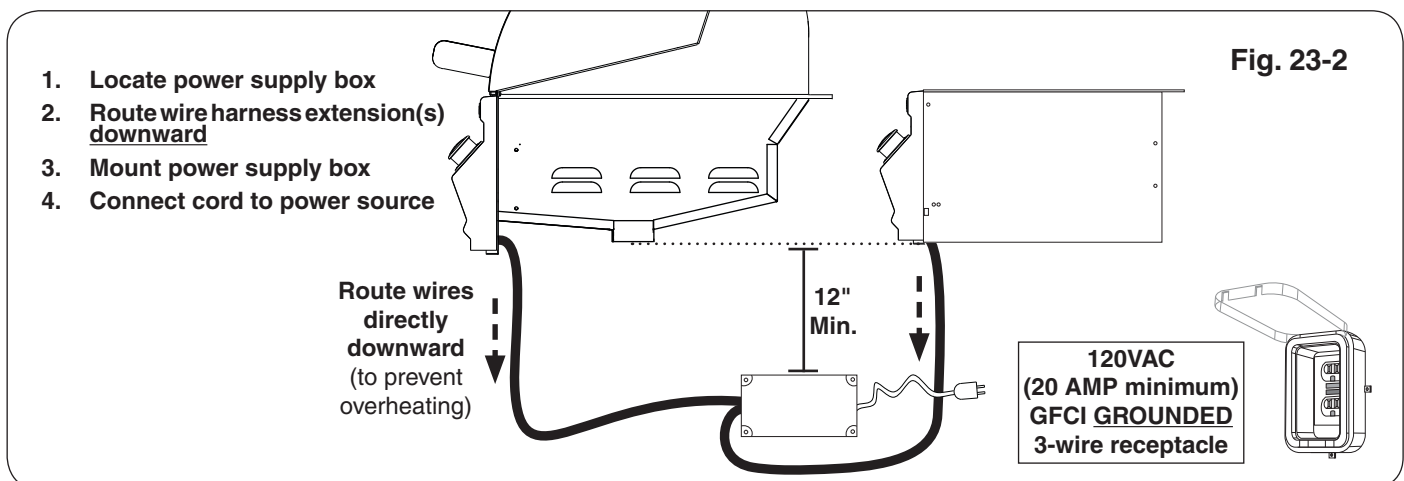

### SLIDE UNIT INTO ENCLOSURE

Slide the unit into place. Do not pinch, kink, or damage the gas connector line.

**Note:** Each side of the unit has a tab just behind the control panel. These tabs prevent the control panel from moving inward. If the tabs interfere with the unit sliding in (see Fig. 24-1), use pliers to bend them inward so that they clear the enclosure sides. Leave the tabs slightly out to ensure they still keep the control panel from moving inward (see Fig. 24-2).

### POSITION THE BURNER CAP(S)

Place the burner cap(s) centered over the burner(s). Ensure that the cap(s) rest securely in place.

### INSTALL THE COOKING GRID

Carefully place the cooking grid onto the front and rear grid rests of the unit.

### INSTALL THE SIDEBURNER LID

Carefully place the lid over the cooking grid area of the unit. It is recommended to keep the lid on when the unit is not in use. **Do not operate the unit with the lid in place.**

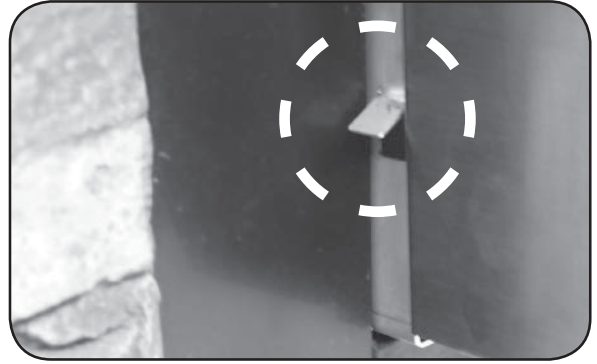

Fig. 24-1 Tab may interfere when sliding in unit

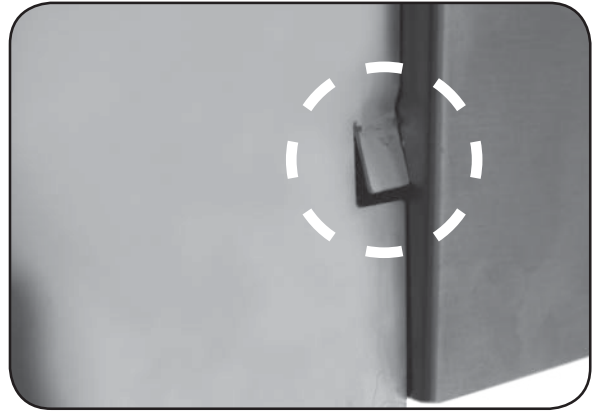
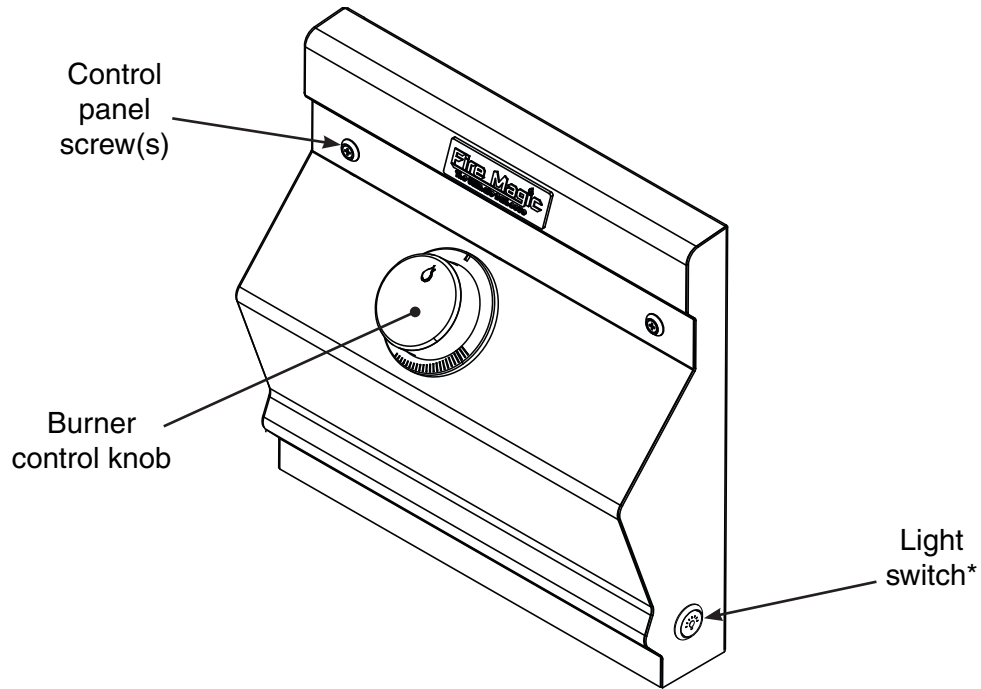

Fig. 24-2 Tab slightly bent in for clearance



# IDENTIFICATION OF CONTROLS



\* The light switch is push button operated, and is located on the right side of the control panel. It controls the power to the lighted knob.

**Fig. 25-1** Single Sideburner controls

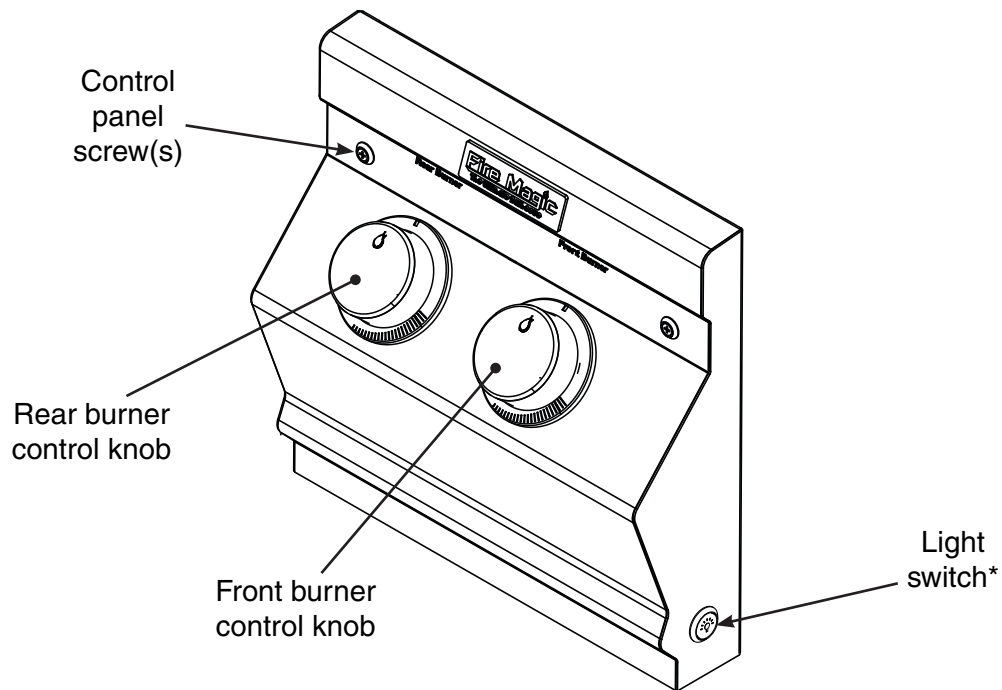

\* The light switch is push button operated, and is located on the right side of the control panel. It controls the power to the lighted knobs.

**Fig. 25-2** Double Sideburner controls

## USING THE APPLIANCE

### BEFORE INITIAL USE

Ensure that:

- the unit has been properly installed and leak tested by a qualified professional service technician and as instructed in this manual.
- you have read and understand all of the information in this manual.

### BEFORE EACH USE

Ensure that:

- you smell around the appliance area for gas. If you smell gas (and all control knobs are in the **OFF** position), immediately shut off the gas supply and contact a qualified professional service technician or the gas supplier for inspection.
- the required vent openings and surrounding area of the unit enclosure are clear at all times.
- the cooking area is clean.
- you inspect all piping and hoses for damage, cuts, wear, and tear. Replace any damaged components prior to use.

### OPERATION

- **The unit becomes HOT during use.**
- **NEVER touch any part of the cooking area or surrounding hot surfaces with bare hands. Use long-handled insulated BBQ tools and wear an insulated glove / oven mitt.**
- **Always keep your face and body as far from the unit as possible during use. Avoid wearing loose-fitting clothing as they could ignite.**
- **NEVER leave the unit unattended during use.**
- **NEVER cover more than 75% of the cooking grid surface with griddles or pans to prevent overheating.**

After reading and understanding all bullets above, follow these steps to light and use your unit:

1. Light the unit per the LIGHTING INSTRUCTIONS section.
2. Turn the control knob(s) to the HI-LIGHT position, place cookware over the burner and allow the cookware to preheat as needed until desired cooking temperature is reached.
3. Place your ingredients on the cookware and cook as desired. Monitor the flames and temperature, and adjust the heat setting if necessary.
4. See the sections below and the following pages for all other information regarding use.

### WIND CONSIDERATIONS

Proper airflow (front-to-back, Fig. 26-1) **MUST** be maintained for the unit to perform as it was designed. See the INSTALLATION REQUIREMENTS section for details.

When using the unit in windy conditions, the wind can disrupt the airflow and cause overheating.

### AFTER EACH USE

5. Clean off any food particles and grease from the stainless steel surfaces once the unit has completely cooled.
6. Cover the unit.

**Note:** For additional cleaning, refer to the SERVICING AND CLEANING section.

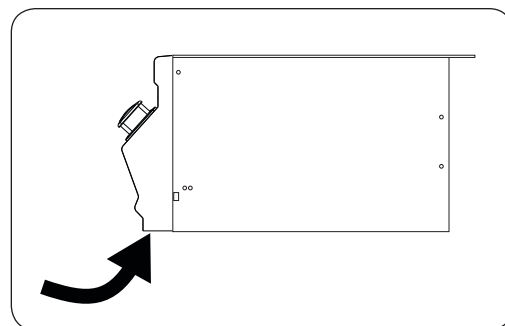

Fig. 26-1 Airflow diagram

# LIGHTING (IGNITION) INSTRUCTIONS

Read all instructions before lighting, and follow these instructions each time you light the unit.

## ELECTRONIC LIGHTING

**Note:** This unit must be connected to 120VAC power for electronic lighting.

1. Open lid(s) or remove cover(s) from burner(s) to be lit.
2. Turn all gas control knob(s) to their **OFF** position(s).
3. Turn on the gas at its source.

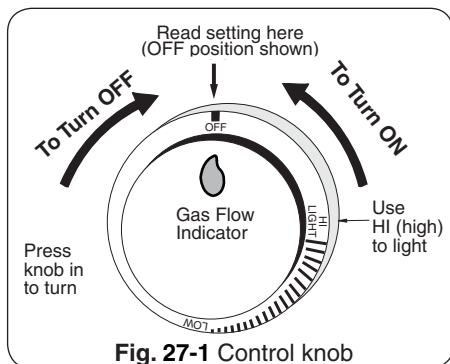

Fig. 27-1 Control knob

**Note:** If equipped, **DO NOT** turn on more than one valve at a time for either electronic or manual lighting.

4. Depress the desired control knob **for 5 seconds**, then, while pressing turn it counterclockwise to the **HI LIGHT** position. Once the burner lights, release the knob.

### CAUTION:

If a burner does not light within five (5) *seconds* of turning on the control knob, depress the knob and turn it to the **OFF** position. **WAIT FIVE (5) MINUTES** before repeating step 4. If you smell gas, follow the instructions on the cover of this manual. If the burners still do not light after several attempts, refer to the instructions for manual lighting.

5. If equipped, repeat step 4 for the second burner to be lit.

## WHEN USING A PORTABLE PROPANE TANK

Propane tanks are equipped with a safety shutdown device that may cause low or no gas pressure/flame at the burners if operating and lighting instructions are not followed exactly (See important note in the TROUBLESHOOTING section for more details.)

## MANUAL LIGHTING

**CAUTION:** Always wait five (5) minutes for gas to clear after any unsuccessful lighting attempt.

1. Follow steps 1 through 3 (left).
2. Insert either a burning long-barrel butane lighter, a burning long-stem match, or a burning match held by a wire extension holder through the cooking grid opening to the burner (Fig. 27-2). Hold the flame against the edge of the burner.
3. While holding the match or lighter flame next to the burner, depress the control knob and while pressing turn it counterclockwise to the **HI LIGHT** position. Remove the lighter or match when the burner lights, and release the control knob.
4. If the burner does not light within five (5) seconds of turning the control knob, **immediately depress the knob and turn the valve to OFF**. **WAIT FIVE (5) MINUTES** before repeating steps 2 through 4 of the MANUAL LIGHTING instructions.



Fig. 27-2 Manual lighting

## SHUTTING OFF THE UNIT

To shut off the unit, depress each valve control knob and while pressing turn it clockwise to the **OFF** position.

Always close the valve from the gas supply after each use of the unit.

**For your convenience and safety; when the control knob is turned to the on position, the gas flow indicator will change from blue to red. (Red indicates gas flow.) See Fig. 27-1.**

# ALLUMAGE DES INSTRUCTIONS (D'ALLUMAGE)

Lisez toutes les instructions avant l'allumage, et suivez ces instructions chaque fois vous lumière le unité.

## ÉCLAIRAGE ÉLECTRONIQUE

**Note:** Le unité doit être relié à la puissance 120VAC pour l'éclairage électronique.

1. Ouvrez les couvercles ou enlevez les couvertures des brûleurs pour être Lit.
2. Tournez tous les boutons de commande de gaz à leurs positions de repos.
3. Allumez le gaz à sa source.

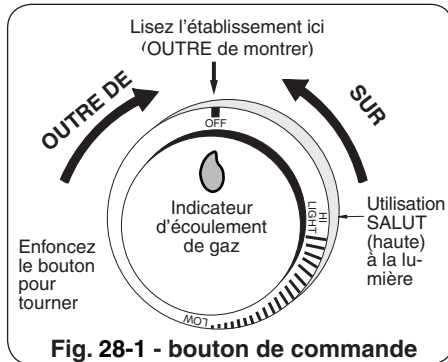

**Remarque:** s'il est équipé, **NE PAS** allumer plus d'une soupape à la fois pour l'éclairage électronique ou manuel.

4. Diminuez le bouton de commande désiré pendant 5 secondes, puis, et tout en pressant le tour il dans le sens contraire des aiguilles d'une montre dans la position LÉGÈRE de HI. Une fois que le brûleur s'allume, libérez le bouton.

**ATTENTION :** Si un brûleur ne s'allume pas dans cinq (5) secondes d'allumer le bouton de commande, enfoncez le bouton et tournez-le à la position de repos. **ATTENDEZ CINQ (5) MINUTES** avant de répéter l'étape 4. Si vous sentez le gaz, suivez les instructions sur la couverture de ce manuel. Si les brûleurs ne s'allument toujours pas après que plusieurs tentatives, se rapportent aux instructions pour l'éclairage manuel.

5. Si équipé, répétez l'étape 4 pour que le deuxième brûleur soit allumé.

## ÉCLAIRAGE MANUEL

**ATTENTION:** Attendez toujours cinq (5) minutes le gaz pour se dégager après que n'importe quelle tentative non réussie d'éclairage.

1. Suivez les étapes 1 à 3 (à gauche).
2. Insérez un allumeur brûlant de butane de long-baril, une allumette brûlante de long-tige, ou une allumette brûlante tenue par un support de prolongation de fil par la grille à cuire s'ouvrant au brûleur (fig. 28-2). Tenez la flamme contre le bord du brûleur.
3. Tout en tenant l'allumette ou la flamme plus légère à côté du brûleur, diminuez le bouton de commande et tout en pressant le tour il dans le sens contraire des aiguilles d'une montre dans la position LÉGÈRE de HI. Enlevez l'allumeur ou assortissez quand le brûleur s'allume, et libérez le bouton de commande.
4. Si le brûleur ne se allume pas dans les cinq (5) secondes de tourner le bouton de commande, enfoncez immédiatement le bouton et tournez la valve à AU LOIN. **ATTENDEZ CINQ (5) MINUTES** avant de répéter les étapes 2 à 4 des instructions manuelles d'éclairage.

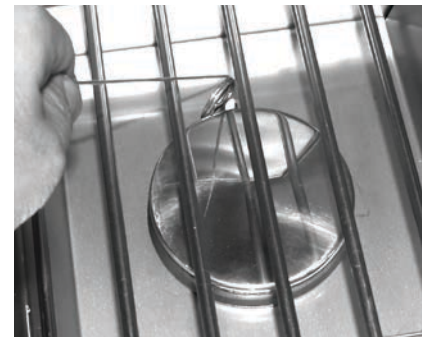

Fig. 28-2 - Éclairage manuel

## ARRÊT DU UNITÉ

Pour couper le unité, diminuez chaque bouton de commande de valve et tout en pressant tour il dans le sens des aiguilles d'une montre à la position de repos.

Fermez toujours la valve de la fourniture de gaz après chaque utilisation du unité.

### EN EMPLOYANT UN RÉSERVOIR DE PROPANE PORTATIF

Des réservoirs de propane sont équipés d'un dispositif d'arrêt de sûreté qui peut ne pas causer le bas ou aucunes pression de gaz/flamme aux brûleurs si le fonctionnement et l'allumage des instructions ne sont pas suivis exactement (voir la note importante dans la section de dépannage pour plus de détails.)

**Pour votre convenance et sûreté ; quand le bouton de commande est tourné a la position de fonctionnement, l'indicateur d'écoulement de gaz changera de bleu en le rouge. (Le rouge indique l'écoulement de gaz.) Voir la Fig. 28-1.**

## SERVICING AND CLEANING

**Your sideburner requires regular cleaning and maintenance.** Refer to these instructions for details. Performing these procedures will ensure proper operation, appearance, and safety.

### WARNINGS

- Prior to servicing or cleaning make sure the unit is completely cool, the control knobs are turned to the OFF position, the gas supply is shut off, the light switch is off, and the power supply is disconnected (as applicable and unless otherwise stated).
- Wear appropriate gloves and safety glasses during any servicing or cleaning.
- DO NOT spray any cleaner or liquids on the unit when hot.
- The unit **MUST** be cleaned regularly to prevent grease build-up and other food deposits. A clean and well maintained unit prevents the risk of grease build-up and grease fires.
- Verify proper operation after servicing or deep cleaning.
- See INSTALLATION, OPERATION, AND SAFETY INFORMATION section for additional related information.

### CLEANING YOUR SIDEBURNER

#### Before Each Use

1. **Inspect and clean the exterior surfaces of the unit:** With a cool sideburner, clean any dust, grease, splatter, or spills as needed with a damp clean cloth.

#### After Each Use

1. **Clean the burner area and cooking grids:** With a cool sideburner, clean any dust, grease, splatter, or spills as needed with a damp clean cloth. If needed, use a grill brush to clean the cooking grids of any residue.
2. **Cover your sideburner:** Once the sideburner is dry and cool, place the sideburner lid and cover your sideburner with a vinyl cover.

#### Twice A Year (or as needed) - Deep Clean

1. **Interior of sideburner (burner area):** In addition to cleaning the burner area and cooking grid, a deep clean of the interior, burners, and all components **MUST** be performed twice a year (or as needed depending on use). Follow the steps below.
  - a. With a cool unit, remove the sideburner lid, cooking grid, burner caps, and burners. Clean all components in a soapy water solution, rinse, dry, and set aside. For tough deposits and burner ports, a copper pad can be used.

**Note:** Refer to the parts list and BURNER REMOVAL section as needed.

**Important:** The burner ports **MUST** be kept clean to ensure proper ignition and operation.

- b. Use a grill cleaner and a copper pad to scrub the burner area. Fire Magic grill cleaner is recommended. Follow instructions provided with the grill cleaner.

Wipe down the entire surface of the burner area with a wet, clean, heavy-duty rag. Remove all cleaner.

- c. Re-install all components removed during this process.

2. **Exterior of sideburner (lid and control panel):** With a cool unit, use a grill cleaner (or a soapy water solution) and a clean cloth to remove grease and dirt from the lid and control panel. For tough deposits, a copper pad can be used. Always wipe with the grain. Rinse and dry completely. Then follow up with a stainless steel cleaner and a clean cloth.

If this routine cleaning is not performed, the stainless steel may become dull and develop surface rust (due to use and atmospheric conditions). If left uncleaned, significant damage and pitting may occur.

**Important:** DO NOT use steel wool, any other metal tools, or any other cleaners/chemicals to clean the exterior other than recommended above. Such items promote rust.

**Note:** Due to the nature of stainless steel, temperatures produced by the cooking process will cause discoloration. This can be reduced by routine cleaning.



Fig. 29-1 Wipe with grain

## SERVICING AND CLEANING (cont.)

### For Environments High In Salt, Chloride, Or Other Corrosive Chemicals

When this sideburner is installed in a corrosive environment such as near the ocean (salt air), poolside (chlorine and/or pool chemicals) or any other location with exposure to high salt/chloride content or corrosive chemicals/solutions, it will be more susceptible to corrosion and **MUST** be maintained/cleaned **more frequently**.

- **DO NOT** store any corrosive chemicals (chlorine, hydrochloric acid, fertilizer, etc.) near your stainless steel unit.
- **DO NOT** allow any corrosive materials (masonry dust, debris, etc.) to settle on your stainless steel unit.
- These environments, chemicals, and materials may cause the 304 stainless steel to develop surface rust and consequently pitting. Under these conditions the sideburner exterior **MUST** be cleaned at least monthly. Inspect your unit often and clean accordingly.

### Protecting Your Sideburner

In addition to the supplied sideburner lid (placed first), an optional vinyl cover will protect your sideburner when not in use. Install the cover on a cool and dry sideburner. **DO NOT** cover a damp sideburner. During high humidity or after rainy conditions, remove the cover to dry trapped moisture if present. (If the cover is installed over a damp sideburner it can cause surface rust.)

Ensure that the **INSIDE** of the cover is DRY before putting it back on the sideburner.

### CONVERT GAS TYPE / CHECK BURNER ORIFICES

**CAUTION:** Make sure the unit is at a safe temperature and is isolated from gas and electrical supplies before beginning.

For your safety, exercise caution, and make sure you have adequate hand protection, such as gloves, when handling metal parts.

#### Apply Conversion Label

This unit comes from the factory configured for one type of gas as marked on the label behind the control panel.

**When the unit is converted, the label for the new gas (included at original shipping) MUST be filled out and applied next to the existing label mentioned above.**

#### Convert Regulator

The gas regulator, located behind the control panel, must be set for the type of gas used to fuel the unit. To check the regulator setting, remove the cap in the center of the regulator (Fig. 31-1, A). Holding the cap vertical (see Fig. 31-2, B), the letters at the bottom of the plastic stalk indicate the gas type for which the regulator is currently configured.

If the text on the bottom of the regulator stalk does not match the gas type connected to the unit, remove the stalk from the cap, invert, and replace into center of cap. Replace cap on the regulator, screwing down until snug.

#### Convert Gas Orifices

When converting the unit to a different gas type, burner orifices must be replaced with the corresponding orifice for the new gas.

See MODEL SPECIFICATIONS, Table 1 to determine the proper orifice size for the burner(s).

**Important:** It is critical to the operation of the burner(s) that its orifice be fully inserted into the center of its orifice opening.

#### **WARNING**

**HAZARDOUS OVERHEATING WILL OCCUR IF A NATURAL-GAS ORIFICE IS USED WITH PROPANE GAS.**

#### Connect To New Gas Supply

Plumb the unit as appropriate for the new gas supply. (Additional components may be needed for your specific setup.) **Be sure to leak test at all connections.**

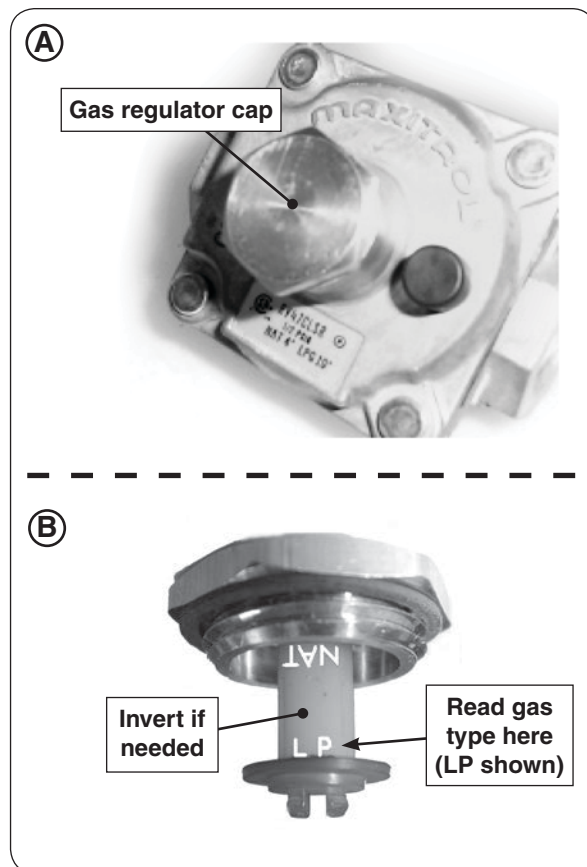

**Fig. 31-1** Convert regulator

Continued on next page

### Convert/Check Burner Orifice

1. Remove the sideburner lid, cooking grid, burner caps, and set them aside.
2. Remove the control panel. See the CONTROL PANEL REMOVAL section for details.
3. Remove the burners. See the BURNER REMOVAL section for details.
4. Using a  $\frac{3}{8}$ " socket nut driver, remove the orifice from the orifice holder (see Fig. 32-1 and Fig. 32-2) and check the number stamped on the orifice face.
5. If an orifice change is necessary, replace the orifice with the correct size.

**Note:** To protect the manifold threads when placing the new orifice, start the threading manually, and then tighten with the nut driver.

6. Replace the sideburner tube over the orifice, aligning the burner over the electrode, taking care not to detach it from the wire.
7. Replace the burner retaining clip (underneath burner), and burner cap.
8. If equipped, repeat steps 4. through 7. for the second burner.
9. Replace the control panel, bezel(s), and control knob(s).
10. Replace the grid and sideburner lid.

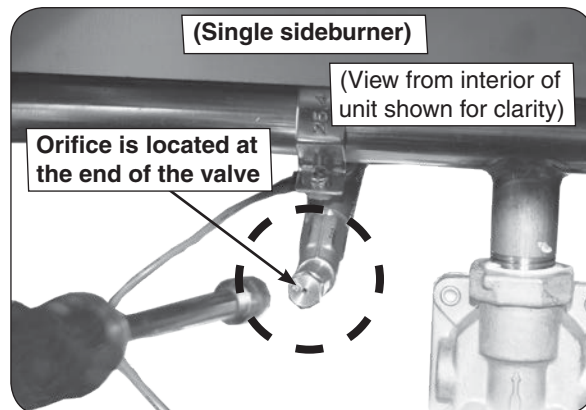

**Fig. 32-1** Single sideburner orifice location

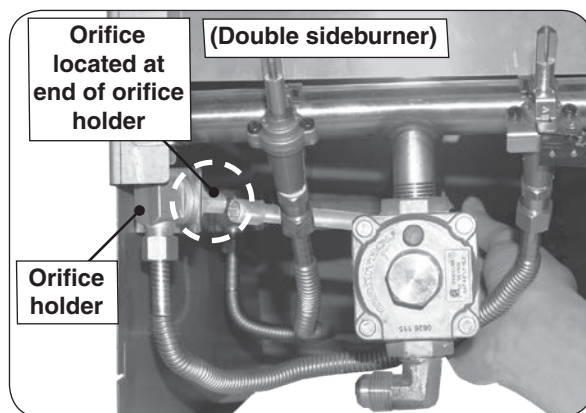

**Fig. 32-2** Double sideburner orifice locations



### AIR SHUTTER ADJUSTMENT

Air shutters are preset at the factory based on the gas the sideburner is built to burn. However, altitude or other local conditions may require air shutter adjustment for proper combustion.

The flames from a properly adjusted sideburner will touch the burner ports and appear mostly blue.

If the flames are orange, “lazy”, or lift off the burner ports, then adjust the sideburner air shutter using the following steps.

The air shutters are located at the end of the burner assemblies, behind the control panel. They can safely and easily be adjusted while the unit is lit.

**CAUTION:** Do not touch the sideburner surrounding top area, as it will be hot while adjusting the air shutter.

1. Remove the control panel. See the CONTROL PANEL REMOVAL section for details.
2. Replace the control knob(s) back on to the valve stem(s).
3. Light the sideburner following the LIGHTING INSTRUCTIONS section.
4. Loosen the burner air shutter adjustment screw, then use the tip of a screwdriver to open or close the air shutter until the flames appear blue and touch the burner ports.
5. Re-tighten the adjustment screw.
6. If equipped, repeat for other burner air shutter.

**Should you have difficulty accessing the rear burner air shutter, you may shut down, remove the rear burner (when cool), then adjust the air shutter to the same opening as the already adjusted front burner. (See BURNER REMOVAL section to remove rear burner.) Be sure to properly reinstall rear burner when complete.**

7. Once all adjustments are complete; be sure the unit is off and remove the knob(s), then replace the control panel, bezel(s), and knob(s).

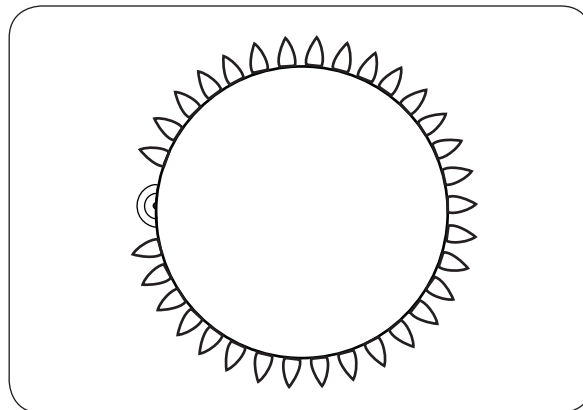

**Fig. 33-1** Flame pattern

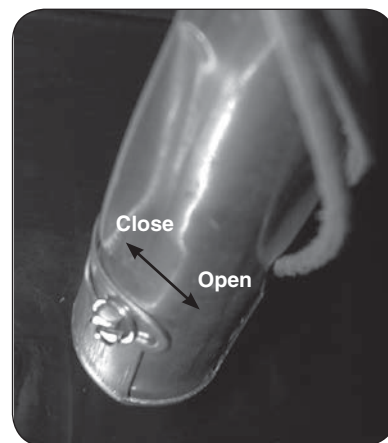

**Fig. 33-2** Adjust air shutter

### CONTROL PANEL REMOVAL

1. Turn the control knob(s) to the OFF position and turn off the gas supply to the unit.
  2. Turn off the light switch and disconnect the power supply from the power source.
  3. Pull the control knob(s) from the stems and set aside.
  4. Slowly lift away the lighted bezels to clear the valve stems, and carefully disconnect the wires found on the back of the bezels (use your fingernail). See Fig. 34-1.
  5. Using a Phillips screwdriver, unscrew and remove the control panel fastener screws and washers (located on the left and right front face of the control panel). Retain the screws for later re-installation.
  6. Carefully open the control panel by lifting and pulling the control panel from the frame.
- Important:** When opening, take caution to not damage any wiring.
7. If wire disconnections are required, reference the wire diagram in the MODEL SPECIFICATIONS section in this instruction manual or the wire diagram label affixed to the inside of the control panel.
- Note:** Secure any disconnected wires (coming from the inside of the unit) to prevent them from falling in.
- Note:** Whenever reconnecting any wires, apply a small amount of dielectric grease to the male connector, then make the connection. This will ensure conductivity and prevent moisture from affecting the contact.
- Important:** During reinstallation; prior to opening the gas shut-off valve, be sure the control knob(s) are in the OFF position.

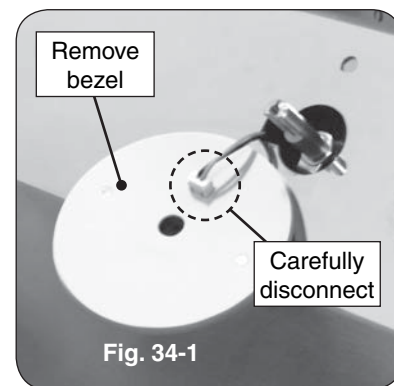

## BURNER REMOVAL

1. Remove the sideburner lid, cooking grid, sideburner caps, and set them aside.
2. Remove the control panel. See the CONTROL PANEL REMOVAL section for details.
3. Reach up under the burner support and remove the burner retaining clip (see Fig. 35-1), located at the rear of the burner pipe.
4. Make note of how the burnertube is installed over the orifice to use as reference when re-installing.
5. Carefully lift the burner up and out, clearing the ceramic electrode (see Fig. 35-2), and pulling the burner tube away from the orifice located on the left side of the unit.
6. To replace, slide the burnertube in through the top opening and carefully slide it over the orifice, aligning the burner over the electrode, taking care not to detach it from the wire.

**Note:** It is critical to the continued safe functioning of the burners that the orifices are centered and completely inside the burner gas inlets.

7. Replace the burner retaining clip (underneath burner). Reference Fig. 35-1.
8. Repeat as needed for the other burner (if applicable).
9. Replace the control panel and all other components.

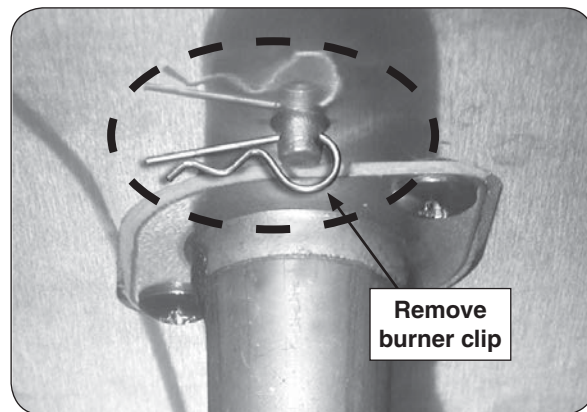

Fig. 35-1 Remove burner clip

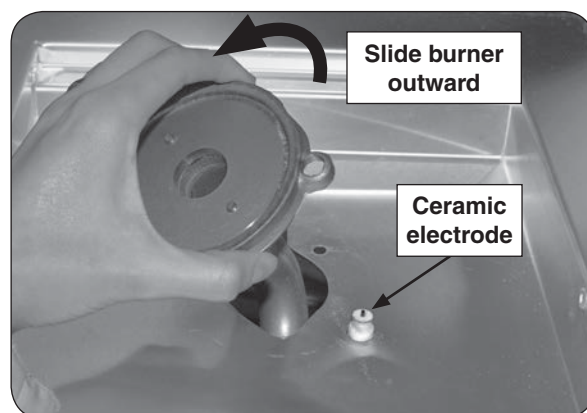

Fig. 35-2 Remove burner

## SYSTEM RESET

If the unit is connected to the power supply but the ignition system and grill components are not functioning, a system reset may be required.

1. **Ensure the knobs are in the OFF position, the gas supply is turned off, and the light switch is off.**
2. Disconnect the power supply cord from line power.
3. Wait 10 minutes then reconnect to line power.
4. With the light switch and gas remaining OFF, test the ignition (inspect hot glow from each igniter) and digital thermometer. Then test the lights.

**Note:** Before testing, reset the GFCI receptacle if needed.

**Note:** If the unit powers up but some or all components are not responding, reference the TROUBLESHOOTING section.

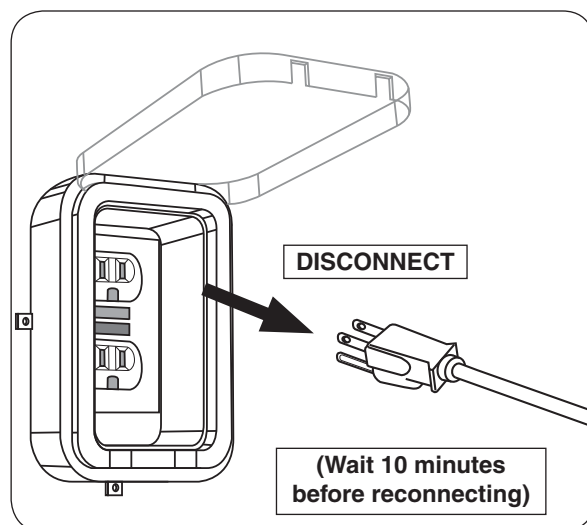

Fig. 35-3 Disconnect from line power

---

**NOTES PAGE**

---

Please use this page to record any information about your unit that you may want to have at hand.

## TROUBLESHOOTING

If you have trouble with the unit, please use this list to identify the problem. By trying one or more of the solutions to the possible cause, you should be able to solve the problem. If this list does not cover your present problem, or if you have other technical difficulties with the unit, please contact your local dealer.

PROBLEM	POSSIBLE CAUSE	CORRECTION
<b>Ignition system failure</b>	<ol style="list-style-type: none"> <li>1. Power supply failure</li> <li>2. Improper air shutter adjustment</li> <li>3. Ignition wire disconnected</li> <li>4. Low gas pressure</li> <li>5. Igniter switch malfunction on valve</li> <li>6. Igniter malfunction</li> </ol>	<ol style="list-style-type: none"> <li>1a. <b>System reset:</b> Disconnect (wait 10 minutes minimum) and reconnect power to unit. With lights <u>OFF</u> (if applicable), test ignition.</li> <li>1b. Replace power supply.</li> <li>2. Adjust air shutters.</li> <li>3. Reconnect wires into wire harness.</li> <li>4. Have the gas co. check supply pressure.</li> <li>5. Contact dealer for replacement.</li> <li>6. Contact dealer for replacement.</li> </ol>
<b>Insufficient heat / low flame</b>	<ol style="list-style-type: none"> <li>1. Burner ports partially blocked by debris</li> <li>2. Improper air-shutter adjustment</li> <li>3. Using propane orifice for natural gas</li> <li>4. Low gas pressure/flame (propane)</li> <li>5. Low gas pressure/flame (natural)</li> <li>6. L.P. regulator hose cracked due to age</li> </ol>	<ol style="list-style-type: none"> <li>1. Remove burners and clean out ports.</li> <li>2. Adjust air shutters.</li> <li>3. Check/change orifices.</li> <li>4. Refill propane tank, or reset propane tank safety*: Shut off all valves (including propane tank) and follow lighting instructions exactly.</li> <li>5. Have a qualified professional service technician check for proper gas supply, setup, and pressure.</li> <li>6. Replace L.P. regulator hose.</li> </ol>
<b>Uneven heating</b>	<ol style="list-style-type: none"> <li>1. Burner ports partially blocked by debris</li> <li>2. Small spiders or insects in burner</li> <li>3. Improper air shutter adjustment</li> </ol>	<ol style="list-style-type: none"> <li>1. Remove burners and clean out ports.</li> <li>2. Inspect burners and orifices for spider webs or other debris that may block flow.</li> <li>3. Adjust air shutter.</li> </ol>
<b>Knob light(s) not operating</b>	<ol style="list-style-type: none"> <li>1. Light switch not functioning</li> <li>2. Interior or knob light(s) burned out</li> <li>3. Power supply failure</li> </ol>	<ol style="list-style-type: none"> <li>1. Re-connect external power to grill or contact dealer for replacement.</li> <li>2. Contact dealer for replacement.</li> <li>3. See 1a of <b>Ignition system failure</b> section above and/or replace power supply.</li> </ol>
<b>Burner goes out on LOW</b>	<ol style="list-style-type: none"> <li>1. Valve "Low" setting needs adjustment</li> </ol>	<ol style="list-style-type: none"> <li>1. Light burner on HIGH, immediately turn to LOW setting. Remove knob from valve and using a small flat screwdriver, slowly turn the adjustment screw in the stem, a little at a time (30° to 45°), in either direction, until the flame is approximately 1/4" in height from burner ports.</li> </ol>
<b>No power to unit</b>	<ol style="list-style-type: none"> <li>1. Input power source failure</li> <li>2. Power supply failure</li> </ol>	<ol style="list-style-type: none"> <li>1. Check GFCI / circuit breaker.</li> <li>2. See 1a of <b>Ignition system failure</b> section above and/or replace power supply.</li> </ol>

**Note:** \*Propane tanks are equipped with a safety shutdown device that may cause low or no gas/flame at the burners if operating and lighting instructions are not followed exactly. **If you suspect the propane tank safety shutoff is in effect:** 1) Shut off all appliance valves. 2) Shut off tank valve. 3) Open and close a burner valve. 4) Open tank valve. 5) Follow the LIGHTING INSTRUCTIONS. Lighting instructions are located in the owner's manual and printed on the front face of the unit. If the problem persists, continue troubleshooting, or contact your local dealer or distributor for assistance.

# WARRANTY

## PETERSON FIRE MAGIC GRILLS AND ACCESSORIES LIMITED WARRANTY

Robert H. Peterson Co. ("RHP") warrants your Fire Magic® grill to be free from defects in material and workmanship. Fire Magic® cast stainless-steel burners, Choice stainless steel tubular burners, stainless-steel cooking grids, and stainless-steel housings are warranted for as long as you own your Fire Magic® grill -- **LIFETIME**. (Except as noted below.) Fire Magic® brass valves, inner liners, manifold assemblies, porcelain housings (including ovens and barbecue faces), and backburner assemblies (except ignition parts) are warranted for **FIFTEEN (15) YEARS**. Fire Magic® built-in and portable griddles (except ignition parts) are warranted for **TEN (10) YEARS**. Fire Magic® Electric Grills, including stainless steel grid, and housings are warranted for **TEN (10) YEARS**. Fire Magic® Infra-red burners, flavor grids, Charcoal stainless steel grills, and Smokers are warranted for **FIVE (5) YEARS**; except for the charcoal pan, charcoal grid, wood pellet screen, thermometer, and ash tray; which are warranted for **ONE (1) YEAR**. Fire Magic® sideburners and all other Fire Magic® grill components (except ignition and electronic parts) are warranted for **THREE (3) YEARS**. Fire Magic® grill and griddle ignition systems (excluding batteries), electronic components (including lights and thermometers), and grill accessories are warranted for **ONE (1) YEAR**.

### A COPY OF YOUR SALES SLIP FOR PROOF OF PURCHASE IS REQUIRED

This warranty applies to the original purchaser for products which are installed in the United States or Canada and which are operated and maintained as intended for single family residential usage. This warranty is valid only with proof of purchase, shall commence on the date of purchase, and shall terminate (both as to original and any replacement products) on the anniversary date of the original purchase of the product stated on the above schedules.

This warranty covers defects in material and workmanship. This warranty **does not** cover parts which become defective as a result of negligence, misuse, use not in compliance with the Owner's Manual/Installation Instructions, accidental damage, improper handling, improper storage, improper installation, **lack of required routine maintenance** (as specified in the Owner's Manual/Installation Instructions), electrical damage, local gas impurities or failure to protect against combustibles. Product must be installed (and gas must be connected) as specified in the Owner's Manual/Installation Instructions by a **qualified professional installer**. Modifications to products which are not specifically authorized will void this warranty. Accessories, parts, valves, remotes, etc. when used must be Peterson products or this warranty is void. Warranted items will be repaired or replaced at Peterson's sole discretion. This warranty **does not** apply to rust, corrosion, oxidation, or discoloration unless the affected part becomes inoperable.

This warranty **does not** cover labor or labor related charges, except as provided by separate specific written programs from the Peterson Co. All repair work must be performed by a qualified professional service person and requires prior approval of Peterson.

Peterson may require the defective product or part to be returned to the factory to determine the cause of failure. Peterson will pay freight charges if the product or part is determined to be defective. This warranty does not cover breakage in shipment from our (Independent) distributor to its customer if the damage is determined to have occurred during that shipment.

This warranty specifically excludes liability for **indirect, incidental, or consequential** damages. Some states and provinces do not allow the exclusion or limitation of incidental or consequential damages, so the above exclusion may not apply to you. This warranty gives you specified legal rights, and you may have other rights that vary from state to state or province.

For additional information regarding this warranty, or to place a warranty claim, contact the R. H. Peterson dealer where the product was purchased.

When contacting your Peterson dealer or the R. H. Peterson Co., please provide the following information:

- Your name, address, telephone number, e-mail
- Sales receipt showing where purchased and date purchased
- Model number, serial number of product, date code
- Relevant information: installer, additions, repairs, when defect was first noted

**TO REGISTER YOUR PRODUCT ONLINE GO TO: WWW.RHPETERSON.COM, AND CLICK ON PRODUCT REGISTRATION. THANK YOU FOR YOUR PURCHASE.**

<b>Quality Check</b>			<b>Date:</b> _____		
<b>Burner Orifices</b>	Nat.	L.P.	<b>Leak Test:</b> _____	<b>Model#:</b> _____	
<b>Main:</b>	_____	_____	<b>Burn Test:</b> _____	<b>Serial#:</b> _____	
<b>Other:</b>	_____	_____	<b>Gas Type:</b> <u>Nat. / L.P.</u>	<b>Air Shutter:</b> _____	
				<b>Inspector:</b> _____	