

# RR1A / RR2A Remote Quick Start Guide

**INSTALLER:** Leave these instructions with consumer.  
**CONSUMER:** Retain for future reference.



This guide serves as a supplement to any remote information found in the burner, pilot kit, and remote instructions. Read all instructions completely and carefully prior to product use. Select models shown, design may vary.

## I INSTALL BATTERIES

### Remote Transmitter

- Remove lid.
- Install "12V" battery (included).
- Re-secure lid.

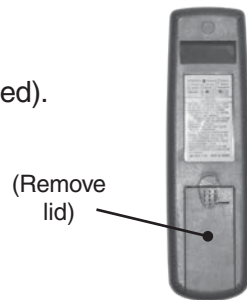

### Remote Receiver

- Remove lid.
- install four "AA" batteries (included).
- Re-secure lid.



## II INSTALL WALL MOUNT (IF APPLICABLE)

### Wall Mount

- For wall mounting: refer to the remote instructions for install details.
- Route the wires to the fireplace and proceed to the following **CONNECT TO VALVE** section.

**Important: DO NOT** install 120VAC wires to remote receiver.

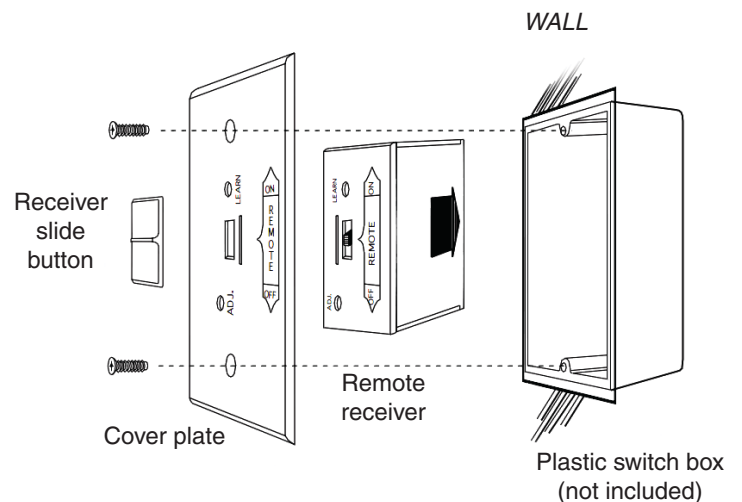

# III CONNECT TO VALVE

The ON/OFF switch must be in off position when using remote system.

## Connecting to a Switch Box Assembly

- Locate two free wires on switch box assembly.
- Connect remote wires.
- Ensure all connections are fully attached.

Switch box assembly design may vary, connection is the same.

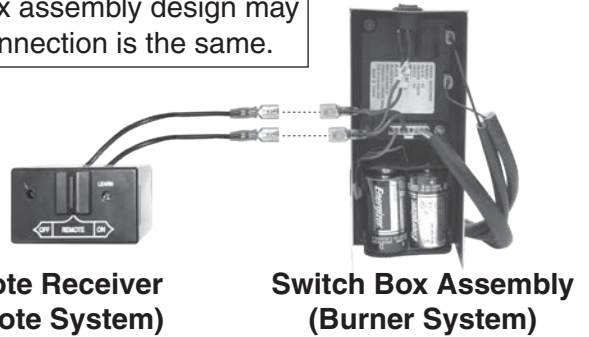

Any ON/OFF or toggle switch (part of burner system) must be in off position when using remote system.

## Connecting to an 11/12 Valve

Two methods exist (depending on model):

### Toggle Switch (and select ON/OFF Switches)

- Locate switch pre-installed to burner valve.
- Remove and discard red connectors on switch (A).
- Connect remote wires to now exposed terminals (B).
- Ensure all connections are fully attached.

**Important: DO NOT** allow terminals to touch.

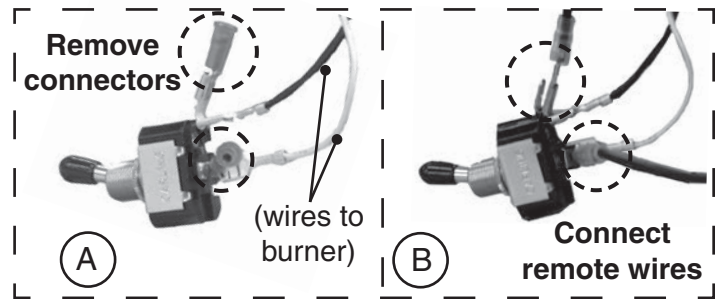

Toggle switch shown (design and location may vary)

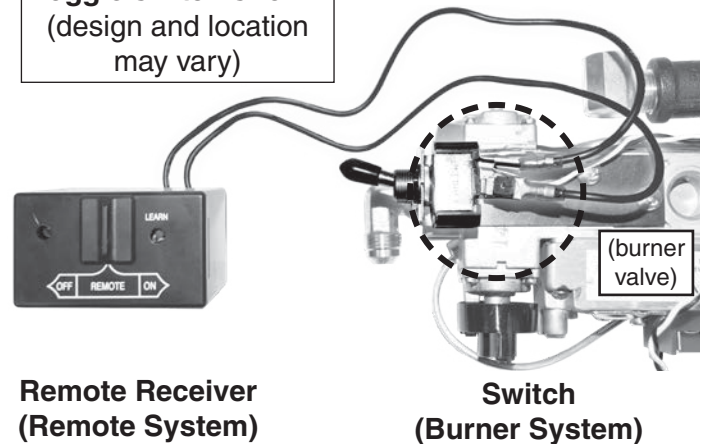

----- OR -----

### Valve

- Connect remote wires to exposed terminals on valve.
- Ensure all connections are fully attached.

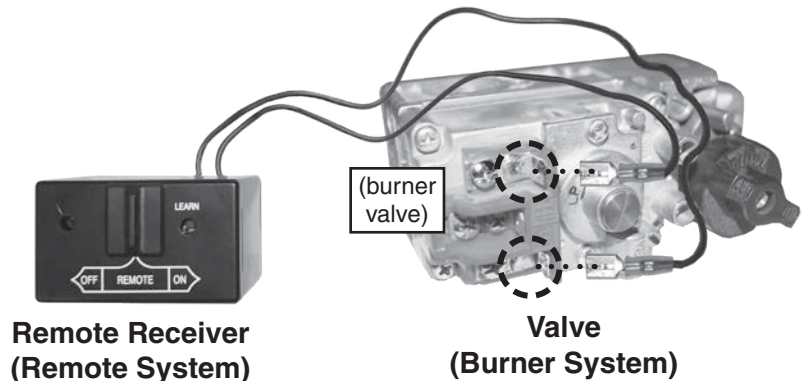

## IV PLACE REMOTE RECEIVER (IF APPLICABLE)

*Proper placement is crucial to prevent damage and overheating.*

### Fireplace

If burner instructions include specific placement instructions, follow them.

- Unless otherwise stated in burner instructions, place receiver at **front right of fireplace** as far from burner system as possible.

**Important: Place receiver 6" from burner/flame (minimum).**

- Place plastic cover over receiver.

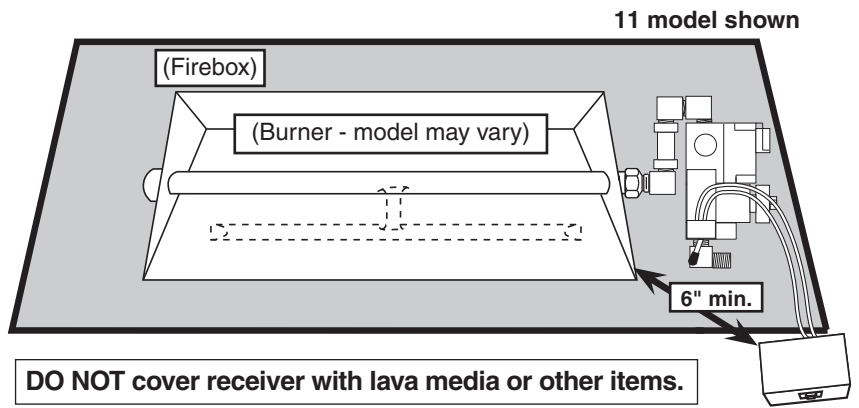

## V PLACE DECORATIVE HEAT SHIELD (IF APPLICABLE)

*Proper placement is crucial to prevent damage and overheating to remote receiver.*

### Fireplace

A decorative heat shield is required to be placed over the remote receiver. Contact your dealer for ordering information (if one was not supplied with your burner system or pilot kit).

- Place the decorative heat shield over the remote receiver.

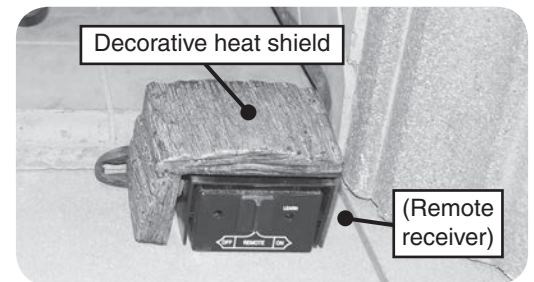

## VI OPERATION

Follow operation section found in burner and/or remote instructions.

**Note:** Any ON/OFF or toggle switch (part of burner system) must be in off position when using remote system.

**Note:** Be sure receiver and transmitter are within 20' - 25' operating range.

**Note:** A triple beeping receiver indicates overheating. Turn off burner, allow to completely cool, and properly relocate receiver (see above section).

## VII SYNCING REMOTE SYSTEM

**Note:** If remote does not function, and batteries with an adequate power level are installed, follow steps below.

Ensure burner system is off and completely cool.

Slide switch on remote receiver to **REMOTE** position. Use the tip of a pen or a wire clip to push the **LEARN** button and release. A beep will be heard. Then press and hold **ON** button on remote transmitter; a series of beeps should be heard. The remote system is now synced. Light burner to test.

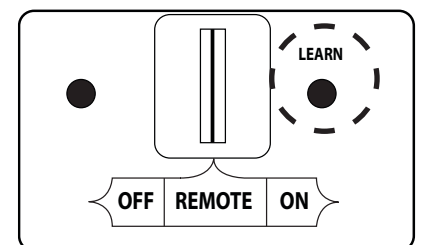

**NOTES PAGE**

Please use this page to record any information that you may want to have at hand.